

2024-2

ÜRÜN KATALOĞU

FİYAT LİSTESİ

+90 344 236 66 55

www.goknurmekatronik.com

www.peopleelektrik.com

info@goknurmekatronik.com

Biz Kimiz?



Biz, Göknur Mekatronik, 1994 yılından beri Kahramanmaraş merkezinde Türkiye'nin endüstriyel kart tamiri alanında faaliyet gösteren ilk 3 firmadan biri olarak faaliyetlerine başlamıştır. 1990'lı yıllarda arızalanan endüstriyel kartın tamir süresinin 2-3 aydan (hatta daha fazla) 2-3 saat gibi bir süreye düşürerek hem üretimin devamını, hem de Türk ekonomisinin gelişmesine katkı sağlamıştır.

Göknur Mekatronik kart tamiri, elektrik-elektronik malzemeleri satışı yanında endüstriyel otomasyon alanında Tekstil, Züccaciye, Geri dönüşüm, Çelik endüstrisi, Kağıt vb. gibi sektörlerde adından söz ettirecek düzeyde Türkiye'de otomasyon projeleri gerçekleştirmiş ve uzman kadrosuyla gerçekleştirilmeye devam etmektedir.

Göknur Mekatronik, sanayici ve imalatçı müşterilerin ihtiyaç duyduğu ürünleri detaylı görüşmeler yaparak yurt dışından bizzat kendi bünyesindeki ekiple tedarik edip yüksek kaliteli ve stoklu ürünleri gelişen teknolojiyi takip ederek müşterilerin hizmetine sunmaktadır. Bu bağlamda Çin'in en büyük endüstriyel ürün tedarikçi ve şalt üreticilerinden biri olan People Electric ile Türkiye Distribütörlük anlaşması imzalamıştır. Ayrıca inverter alanında yine Çin'in en büyük üreticisi Sinovo marka ile Türkiye mümessillik anlaşması imzalayarak kaliteli ve uygun fiyatlı ürünleri bünyesine katmıştır. Harmonik ve Kompanzasyon alanında da yine dünya markası olan İspanya üretimi Lifasa ile güç birliğine gitmiştir.

Göknur Mekatronik, müşteri memnuniyetini karşılıklı ilişkilerde maddiyattan ziyade güvenin ön planda olduğu ilke doğrultusunda elektrik-elektronik malzeme satışı ve otomasyon alanında birçok yerli ve yabancı firma distribütörlükleri ve bayiliklerle yeni yerinde siz değerli müşterilerimize uzman kadrosuyla hizmet etmeye devam edecektir

MİSYONUMUZ

Sanayici ve İmalatçı müşterilerimizin ihtiyaç duydukları ürünleri, detaylı görüşmeler yaparak, yurt dışında bizzat, titizlikle seçtiği tedarikçi firmalardan yüksek kaliteli ve düzenli ürünler temin ederek müşterilerine aksamasız hizmet vermek, gelişen teknolojiyi takip ederek talep edilen yeni ürünleri derhal müşterilerine temin etmek ve buna paralel olarak kendisini geliştirmek, GÖKNUR'un kuruluşundan bu yana misyonu olmuştur.

VİZYONUMUZ

Müşteri memnuniyetini, karşılıklı ilişkilerde maddiyattan ziyade güveni sağlamak ve siz değerli müşterilerimizin ihtiyaçları doğrultusunda kaliteli ve ekonomik ürünlerle elektrik – elektronik malzemeleri ihtiyaçlarınızı en mükemmel şekilde karşılamayı ilke edinen GÖKNUR disiplinli, teknik açıdan profesyonel ve güler yüzlü personeli ile daima en iyi hizmet anlayışıyla çalışmak ve Elektronik sektöründe hizmet veren firmalar arasında güven duyulan lider bir firma olmak.

DEĞERLERİMİZ

Değerlerimiz müşterilerimize her zaman daha iyi bir hizmet verebilmek gayesi ile en yeni teknolojileri kullanarak çözümler üretmektedir. Güvenilirlik, Duyarlılık, Müşteri Odaklılık, Açıklık, Çözüm Odaklılık, Tutkulu Olmak ve Özverili Esneklik. Hizmetlerimiz: Otomasyon Sistemleri / Mekatronik Sistemleri / Teknik Servis Ve Bakım Onarım / Ultrasonik kaynak seti temini / Akıllı Bina Otomasyon Sistemleri

	IEC/EN 60898-1 230/400 V AC 50/60 Hz	Anma Akımı In(A)	Sipariş Kodu B Type	Sipariş Kodu C Type	Kutu Adeti	Birim Fiyat (USD)
1 KUTUP	DZ47-63 Serisi 1P 3kA	2A	G104101	G105501	12	3,50
	DZ47-63 Serisi 1P 3kA	6A	G104103	G105503	12	3,00
	DZ47-63 Serisi 1P 3kA	10A	G104104	G105504	12	3,00
	DZ47-63 Serisi 1P 3kA	16A	G104105	G105505	12	3,00
	DZ47-63 Serisi 1P 3kA	20A	G104106	G105506	12	3,00
	DZ47-63 Serisi 1P 3kA	25A	G104107	G105507	12	3,10
	DZ47-63 Serisi 1P 3kA	32A	G104108	G105508	12	3,10
	DZ47-63 Serisi 1P 3kA	40A	G104109	G105509	12	3,20
	DZ47-63 Serisi 1P 3kA	50A	G104110	G105510	12	3,30
DZ47-63 Serisi 1P 3kA	63A	G104111	G105511	12	3,30	
2 KUTUP	DZ47-63 Serisi 2P 3kA	2A	G104201	G105601	6	8,20
	DZ47-63 Serisi 2P 3kA	6A	G104203	G105603	6	6,80
	DZ47-63 Serisi 2P 3kA	10A	G104204	G105604	6	6,80
	DZ47-63 Serisi 2P 3kA	16A	G104205	G105605	6	6,80
	DZ47-63 Serisi 2P 3kA	20A	G104206	G105606	6	6,80
	DZ47-63 Serisi 2P 3kA	25A	G104207	G105607	6	6,90
	DZ47-63 Serisi 2P 3kA	32A	G104208	G105608	6	6,90
	DZ47-63 Serisi 2P 3kA	40A	G104209	G105609	6	7,00
	DZ47-63 Serisi 2P 3kA	50A	G104210	G105610	6	8,10
DZ47-63 Serisi 2P 3kA	63A	G104211	G105611	6	8,10	
3 KUTUP	DZ47-63 Serisi 3P 3kA	2A	G104301	G105701	4	11,00
	DZ47-63 Serisi 3P 3kA	6A	G104303	G105703	4	10,00
	DZ47-63 Serisi 3P 3kA	10A	G104304	G105704	4	10,00
	DZ47-63 Serisi 3P 3kA	16A	G104305	G105705	4	10,00
	DZ47-63 Serisi 3P 3kA	20A	G104306	G105706	4	10,00
	DZ47-63 Serisi 3P 3kA	25A	G104307	G105707	4	10,20
	DZ47-63 Serisi 3P 3kA	32A	G104308	G105708	4	10,20
	DZ47-63 Serisi 3P 3kA	40A	G104309	G105709	4	10,30
	DZ47-63 Serisi 3P 3kA	50A	G104310	G105710	4	11,40
DZ47-63 Serisi 3P 3kA	63A	G104311	G105711	4	11,40	
4 KUTUP	DZ47-63 Serisi 4P 3kA	2A	G104401	G105801	3	15,30
	DZ47-63 Serisi 4P 3kA	6A	G104403	G105803	3	15,00
	DZ47-63 Serisi 4P 3kA	10A	G104404	G105804	3	15,00
	DZ47-63 Serisi 4P 3kA	16A	G104405	G105805	3	15,00
	DZ47-63 Serisi 4P 3kA	20A	G104406	G105806	3	15,00
	DZ47-63 Serisi 4P 3kA	25A	G104407	G105807	3	15,20
	DZ47-63 Serisi 4P 3kA	32A	G104408	G105808	3	15,30
	DZ47-63 Serisi 4P 3kA	40A	G104409	G105809	3	15,30
	DZ47-63 Serisi 4P 3kA	50A	G104410	G105810	3	15,50
DZ47-63 Serisi 4P 3kA	63A	G104411	G105811	3	15,50	



IEC/EN 60898-1
230/400 V AC 50/60 Hz

Anma Akımı In(A)

Sipariş Kodu
B Type

Sipariş Kodu
C Type

Kutu Adeti

Birim Fiyat
(USD)

1 KUTUP

RDB5-63 Serisi 1P 6kA 2A	2A	G108701	G109101	12	5,10
RDB5-63 Serisi 1P 6kA 6A	6A	G108703	G109103	12	4,40
RDB5-63 Serisi 1P 6kA 10A	10A	G108704	G109104	12	4,10
RDB5-63 Serisi 1P 6kA 16A	16A	G108705	G109105	12	4,10
RDB5-63 Serisi 1P 6kA 20A	20A	G108706	G109106	12	4,10
RDB5-63 Serisi 1P 6kA 25A	25A	G108707	G109107	12	4,10
RDB5-63 Serisi 1P 6kA 32A	32A	G108708	G109108	12	4,60
RDB5-63 Serisi 1P 6kA 40A	40A	G108709	G109109	12	5,10
RDB5-63 Serisi 1P 6kA 50A	50A	G108710	G109110	12	5,60
RDB5-63 Serisi 1P 6kA 63A	63A	G108711	G109111	12	6,00



2 KUTUP

RDB5-63 Serisi 2P 6kA 2A	2A	G108801	G109101	6	12,50
RDB5-63 Serisi 2P 6kA 6A	6A	G108803	G109103	6	10,50
RDB5-63 Serisi 2P 6kA 10A	10A	G108804	G109104	6	10,00
RDB5-63 Serisi 2P 6kA 16A	16A	G108805	G109105	6	10,00
RDB5-63 Serisi 2P 6kA 20A	20A	G108806	G109106	6	10,00
RDB5-63 Serisi 2P 6kA 25A	25A	G108807	G109107	6	10,00
RDB5-63 Serisi 2P 6kA 32A	32A	G108808	G109108	6	12,00
RDB5-63 Serisi 2P 6kA 40A	40A	G108809	G109109	6	12,50
RDB5-63 Serisi 2P 6kA 50A	50A	G108810	G109110	6	14,30
RDB5-63 Serisi 2P 6kA 63A	63A	G108811	G109111	6	15,00



3 KUTUP

RDB5-63 Serisi 3P 6kA 2A	2A	G106101	G109101	4	18,00
RDB5-63 Serisi 3P 6kA 6A	6A	G106103	G109103	4	15,00
RDB5-63 Serisi 3P 6kA 10A	10A	G106104	G109104	4	15,00
RDB5-63 Serisi 3P 6kA 16A	16A	G106105	G109105	4	15,00
RDB5-63 Serisi 3P 6kA 20A	20A	G106106	G109106	4	15,00
RDB5-63 Serisi 3P 6kA 25A	25A	G106107	G109107	4	15,00
RDB5-63 Serisi 3P 6kA 32A	32A	G106108	G109108	4	17,50
RDB5-63 Serisi 3P 6kA 40A	40A	G106109	G109109	4	19,00
RDB5-63 Serisi 3P 6kA 50A	50A	G106110	G109110	4	21,00
RDB5-63 Serisi 3P 6kA 63A	63A	G106111	G109111	4	22,50



4 KUTUP

RDB5-63 Serisi 4P 6kA 2A	2A	G108001	G109101	3	26,50
RDB5-63 Serisi 4P 6kA 6A	6A	G108003	G109103	3	21,50
RDB5-63 Serisi 4P 6kA 10A	10A	G108004	G109104	3	21,50
RDB5-63 Serisi 4P 6kA 16A	16A	G108005	G109105	3	21,50
RDB5-63 Serisi 4P 6kA 20A	20A	G108006	G109106	3	21,50
RDB5-63 Serisi 4P 6kA 25A	25A	G108007	G109107	3	21,50
RDB5-63 Serisi 4P 6kA 32A	32A	G108008	G109108	3	23,00
RDB5-63 Serisi 4P 6kA 40A	40A	G108009	G109109	3	25,00
RDB5-63 Serisi 4P 6kA 50A	50A	G108010	G109110	3	26,00
RDB5-63 Serisi 4P 6kA 63A	63A	G108011	G109111	3	28,00



IEC/EN 60898-1
230/400 V AC 50/60 Hz

Anma Akımı In(A)

Sipariş Kodu
B Type

Sipariş Kodu
C Type

Kutu Adeti

Birim Fiyat
(USD)

1 KUTUP

RDX6-63 Serisi 1P 10kA	2A	G110101	G111501	12	9,50
RDX6-63 Serisi 1P 10kA	6A	G110102	G111502	12	8,10
RDX6-63 Serisi 1P 10kA	10A	G110103	G111503	12	7,00
RDX6-63 Serisi 1P 10kA	16A	G110104	G111504	12	7,00
RDX6-63 Serisi 1P 10kA	20A	G110105	G111505	12	7,00
RDX6-63 Serisi 1P 10kA	25A	G110106	G111506	12	7,00
RDX6-63 Serisi 1P 10kA	32A	G110107	G111507	12	7,40
RDX6-63 Serisi 1P 10kA	40A	G110108	G111508	12	8,20
RDX6-63 Serisi 1P 10kA	50A	G110109	G111509	12	9,00
RDX6-63 Serisi 1P 10kA	63A	G110110	G111510	12	10,00



2 KUTUP

RDX6-63 Serisi 2P 10kA	2A	G110201	G111601	6	22,00
RDX6-63 Serisi 2P 10kA	6A	G110202	G111602	6	20,00
RDX6-63 Serisi 2P 10kA	10A	G110203	G111603	6	18,00
RDX6-63 Serisi 2P 10kA	16A	G110204	G111604	6	18,00
RDX6-63 Serisi 2P 10kA	20A	G110205	G111605	6	18,00
RDX6-63 Serisi 2P 10kA	25A	G110206	G111606	6	18,00
RDX6-63 Serisi 2P 10kA	32A	G110207	G111607	6	22,50
RDX6-63 Serisi 2P 10kA	40A	G110208	G111608	6	23,50
RDX6-63 Serisi 2P 10kA	50A	G110209	G111609	6	25,00
RDX6-63 Serisi 2P 10kA	63A	G110210	G111610	6	26,50



3 KUTUP

RDX6-63 Serisi 3P 10kA	2A	G110301	G111701	4	30,00
RDX6-63 Serisi 3P 10kA	6A	G110302	G111702	4	24,00
RDX6-63 Serisi 3P 10kA	10A	G110303	G111703	4	22,50
RDX6-63 Serisi 3P 10kA	16A	G110304	G111704	4	22,50
RDX6-63 Serisi 3P 10kA	20A	G110305	G111705	4	22,50
RDX6-63 Serisi 3P 10kA	25A	G110306	G111706	4	22,50
RDX6-63 Serisi 3P 10kA	32A	G110307	G111707	4	24,50
RDX6-63 Serisi 3P 10kA	40A	G110308	G111708	4	27,00
RDX6-63 Serisi 3P 10kA	50A	G110309	G111709	4	30,00
RDX6-63 Serisi 3P 10kA	63A	G110310	G111710	4	34,00



4 KUTUP

RDX6-63 Serisi 4P 10kA	2A	G114101	G111801	3	42,50
RDX6-63 Serisi 4P 10kA	6A	G114102	G111802	3	35,50
RDX6-63 Serisi 4P 10kA	10A	G114103	G111803	3	32,00
RDX6-63 Serisi 4P 10kA	16A	G114104	G111804	3	32,00
RDX6-63 Serisi 4P 10kA	20A	G114105	G111805	3	32,00
RDX6-63 Serisi 4P 10kA	25A	G114106	G111806	3	32,00
RDX6-63 Serisi 4P 10kA	32A	G114107	G111807	3	33,50
RDX6-63 Serisi 4P 10kA	40A	G114108	G111808	3	34,50
RDX6-63 Serisi 4P 10kA	50A	G114109	G111809	3	43,00
RDX6-63 Serisi 4P 10kA	63A	G114110	G111810	3	50,00



IEC/EN 60898-1

220/400 V AC 50/60 Hz

Anma Akımı In(A)

Sipariş Kodu

Kutu Adeti

Birim Fiyat (USD)

1 KUTUP

RDX2-125 Serisi	1P 10kA	40A	G112901	12	14,00
RDX2-125 Serisi	1P 10kA	63A	G112902	12	14,00
RDX2-125 Serisi	1P 10kA	80A	G112903	12	16,00
RDX2-125 Serisi	1P 10kA	100A	G112904	12	18,00
RDX2-125 Serisi	1P 10kA	125A	G112905	12	22,00



2 KUTUP

RDX2-125 Serisi	2P 10kA	40A	G112906	6	24,00
RDX2-125 Serisi	2P 10kA	63A	G112907	6	24,00
RDX2-125 Serisi	2P 10kA	80A	G112908	6	37,00
RDX2-125 Serisi	2P 10kA	100A	G112909	6	47,00
RDX2-125 Serisi	2P 10kA	125A	G112910	6	54,00



3 KUTUP

RDX2-125 Serisi	3P 10kA	40A	G112911	4	36,00
RDX2-125 Serisi	3P 10kA	63A	G112912	4	36,00
RDX2-125 Serisi	3P 10kA	80A	G112913	4	57,00
RDX2-125 Serisi	3P 10kA	100A	G112914	4	63,00
RDX2-125 Serisi	3P 10kA	125A	G112915	4	69,00



4 KUTUP

RDX2-125 Serisi	4P 10kA	40A	G112916	3	48,55
RDX2-125 Serisi	4P 10kA	63A	G112917	3	48,55
RDX2-125 Serisi	4P 10kA	80A	G112918	3	78,36
RDX2-125 Serisi	4P 10kA	100A	G112919	3	85,44
RDX2-125 Serisi	4P 10kA	125A	G112920	3	94,56



Teknik Özellikler

RDX-2-125

GENEL ÖZELLİKLER

- Standart: IEC / EN 6094 / 60898 GB10963-89,BS3871
- Koruma sınıfı: IP20
- Elektrik oranı: AC 50/60Hz, AC 230-400V / 240-415V
- Ortam hava sıcaklığı: -5 ... + 40°C
- Bağıl nem: S90%
- Ürün, bariz sarsıntı, darbe veya titreşim olmayan bir yere kurulmalı ve çalıştırılmalıdır.

ELEKTRİKSEL ÖZELLİKLER

- Nominal yalıtım gerilimi Ui: 500V
- Nominal çalışma gerilimi Ue: 230/240V, 400/415V
- Elektrik/Mekanik Ömür: 1500/8000
- Anlık Darbe Dayanım Gerilimi : 4000V

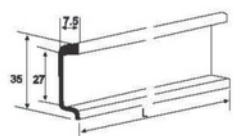
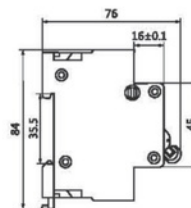
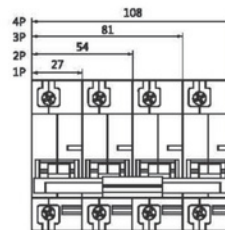

IEC/EN 61008-1
230/440 V AC 50/60 Hz

Anma Akımı In(A)

Sipariş Kodu

Kutu Adeti

Birim Fiyat
(USD)

2 KUTUP 30 mA	PID-63 Serisi 2P 6kA AC type 30mA	25A	G113101	1	26,20
	PID-63 Serisi 2P 6kA AC type 30mA	40A	G113102	1	26,40
	PID-63 Serisi 2P 6kA AC type 30mA	63A	G113103	1	29,50
	PID-63 Serisi 2P 6kA AC type 30mA	80A	G113104	1	38,30
	PID-63 Serisi 2P 6kA AC type 30mA	100A	G113105	1	44,90

2 KUTUP 300 mA	PID-63 Serisi 2P 6kA AC type 300mA	25A	G113111	1	26,20
	PID-63 Serisi 2P 6kA AC type 300mA	40A	G113112	1	26,40
	PID-63 Serisi 2P 6kA AC type 300mA	63A	G113113	1	29,50
	PID-63 Serisi 2P 6kA AC type 300mA	80A	G113114	1	37,10
	PID-63 Serisi 2P 6kA AC type 300mA	100A	G113115	1	42,00

4 KUTUP 30 mA	PID-125 Serisi 4P 6kA AC type 30mA	25A	G113201	1	37,00
	PID-125 Serisi 4P 6kA AC type 30mA	40A	G113202	1	37,00
	PID-125 Serisi 4P 6kA AC type 30mA	63A	G113203	1	40,00
	PID-125 Serisi 4P 6kA AC type 30mA	80A	G113204	1	56,00
	PID-125 Serisi 4P 6kA AC type 30mA	100A	G113205	1	62,00
	PID-125 Serisi 4P 6kA AC type 30mA	125A	G113206	1	70,00

4 KUTUP 300 mA	PID-125 Serisi 4P 6kA AC type 300mA	25A	G113211	1	37,00
	PID-125 Serisi 4P 6kA AC type 300mA	40A	G113212	1	37,00
	PID-125 Serisi 4P 6kA AC type 300mA	63A	G113213	1	40,00
	PID-125 Serisi 4P 6kA AC type 300mA	80A	G113214	1	56,00
	PID-125 Serisi 4P 6kA AC type 300mA	100A	G113215	1	62,00
	PID-125 Serisi 4P 6kA AC type 300mA	125A	G113216	1	70,00



Teknik Özellikler

PID Serisi

GENEL ÖZELLİKLER

- Standart: IEC / EN 61008-1
- Koruma sınıfı: IP20
- Elektrik oranı: AC 50/60Hz, AC 230-400V
- Ortam hava sıcaklığı: -5 ... + 40°C
- Bağıl nem: S90%
- Kirlilik derecesi: III
- Ürün, bariz sarsıntı, darbe veya titreşim olmayan bir yere kurulmalı ve çalıştırılmalıdır.

ELEKTRİKSEL ÖZELLİKLER

- Nominal yalıtım gerilimi Ui: 500V
- Nominal çalışma gerilimi Ue: 230/240V, 400/415V
- Elektrik/Mekanik Ömür: 4000/10000
- Kaçak Olma Durumu ve Kesme Kapasitesi Im: 1250A

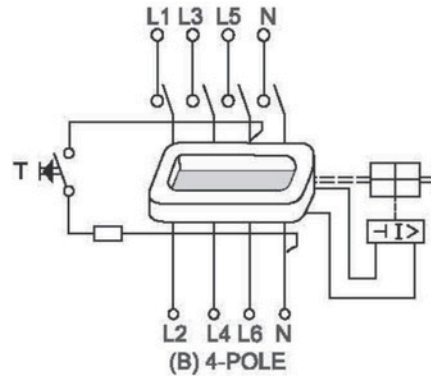
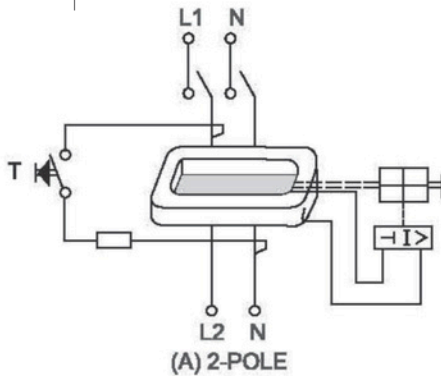
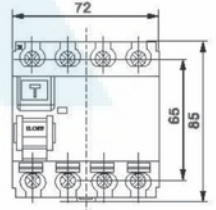
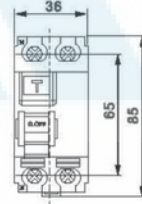
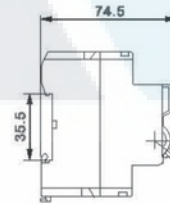

	Ürün (120kA)	Genişlik (mm)	Anma Akımı In(A)	Sipariş Kodu	Kutu Adeti	Tek İndikatörlü Birim Fiyat (USD)	Çift İndikatörlü Birim Fiyat (USD)
NT00	NT00-160 4A	29	4	G165001	1	5,40	5,90
	NT00-160 6A	29	6	G165002	1	5,40	5,90
	NT00-160 10A	29	10	G165003	1	5,40	5,90
	NT00-160 16A	29	16	G165004	1	5,40	5,90
	NT00-160 20A	29	20	G165005	1	5,40	5,90
	NT00-160 25A	29	25	G165006	1	5,40	5,90
	NT00-160 32A	29	32	G165007	1	5,40	5,90
	NT00-160 36A	29	36	G165008	1	5,40	5,90
	NT00-160 40A	29	40	G165009	1	5,40	5,90
	NT00-160 50A	29	50	G165010	1	5,40	5,90
	NT00-160 63A	29	63	G165011	1	5,40	5,90
	NT00-160 80A	29	80	G165012	1	5,40	5,90
	NT00-160 100A	29	100	G165013	1	5,40	5,90
	NT00-160 125A	29	125	G165014	1	5,40	5,90
NT00-160 160A	29	160	G165015	1	5,40	5,90	
NT0	NT0-160 4A	29	4	G165101	1	7,50	8,00
	NT0-160 6A	29	6	G165102	1	7,50	8,00
	NT0-160 10A	29	10	G165103	1	7,50	8,00
	NT0-160 16A	29	16	G165104	1	7,50	8,00
	NT0-160 20A	29	20	G165105	1	7,50	8,00
	NT0-160 25A	29	25	G165106	1	7,50	8,00
	NT0-160 32A	29	32	G165107	1	7,50	8,00
	NT0-160 36A	29	36	G165108	1	7,50	8,00
	NT0-160 40A	29	40	G165109	1	7,50	8,00
	NT0-160 50A	29	50	G165110	1	7,50	8,00
	NT0-160 63A	29	63	G165111	1	7,50	8,00
	NT0-160 80A	29	80	G165112	1	7,50	8,00
NT1	NT1-160 80A	48	80	G165201	1	11,00	11,50
	NT1-160 100A	48	100	G165202	1	11,00	11,50
	NT1-160 125A	48	125	G165203	1	11,00	11,50
	NT1-160 160A	48	160	G165204	1	11,00	11,50
	NT1-160 200A	48	200	G165205	1	11,00	11,50
	NT1-160 225A	48	225	G165206	1	11,00	11,50
NT2	NT2-160 250A	48	250	G165207	1	11,00	11,50
	NT2-160 125A	58	125	G165301	1	16,50	17,00
	NT2-160 160A	58	160	G165302	1	16,50	17,00
	NT2-160 200A	58	200	G165303	1	16,50	17,00
	NT2-160 250A	58	250	G165304	1	16,50	17,00
	NT2-160 300A	58	300	G165305	1	16,50	17,00
	NT2-160 315A	58	315	G165306	1	16,50	17,00
	NT2-160 355A	58	355	G165307	1	16,50	17,00
NT3	NT2-160 400A	58	400	G165308	1	16,50	17,00
	NT3-160 315A	67	315	G165401	1	27,02	30,00
	NT3-160 400A	67	400	G165402	1	27,02	30,00
	NT3-160 450A	67	450	G165403	1	27,02	30,00
	NT3-160 500A	67	500	G165404	1	27,02	30,00
NT4	NT3-160 630A	67	630	G165405	1	27,02	30,00
	NT4-160 630A	67	630	G165501	1	110,00	-
	NT4-160 800A	67	800	G165502	1	115,00	-
	NT4-160 1000A	88	1000	G165503	1	121,00	-
NT4-160 1250A	88	1250	G165504	1	132,00	-	



NT36 BIÇAKLI SİGORTA ALTIKLAR

Boy	Ürün (120kA)	Sipariş Kodu	Kutu Adedi	Birim Fiyat (USD)
00	NT-00-160A	G165601	1	6,02
0	NT-0-160A	G165701	1	10,64
1	NT-1-250A	G165801	1	15,85
2	NT-2-400A	G165901	1	26,12
3	NT-3-630A	G166001	1	37,74
4	NT-4-1000A	G166101	1	117,37



HRB YÜK AYIRICI YATAY TİP

Ürün (50/120kA)	Sipariş Kodu	Kutu Adedi	Birim Fiyat (USD)
HR17B-160	G166201	1	99,90
HR17B-250	G166202	1	115,28
HR17B-400	G166203	1	177,30
HR17B-630	G166204	1	269,24
HG2B-160/3L	G166205	1	294,42
HG2B-250/3L(S)	G166206	1	330,40
HG2B-400/3L(S)	G166207	1	363,26
HG2B-630/3L(S)	G166208	1	470,51



PEOPLE | INNOVATIVE TECHNOLOGY
ELECTRIC | LEADING THE ELECTRICITY

IEC/EN 60947-2
400-690 V AC 50/60 Hz

Anma Akımı In(A)

Sipariş Kodu

Kutu Adeti

Birim Fiyat
(USD)

YARDIMCI KONTAK

RDM1-100	100	G190001	1	6,34
RDM1-225	225	G190002	1	6,34
RDM1-400	400	G190003	1	13,64
RDM1-630	630	G190004	1	13,64
RDM1-800	800	G190005	1	21,44
RDM1-1250	1250	G190006	1	37,04



AÇTIRMA BOBİNİ

RDM1-100/225	100/225	G190101	1	9,26
RDM1-400/630	400/630	G190102	1	37,04
RDM1-800	800	G190103	1	56,53
RDM1-1250	1250	G190104	1	63,37



ALARM KONTAĞI

RDM1-100	100	G200001	1	6,34
RDM1-225	225	G200002	1	7,40
RDM1-400	400	G200003	1	13,64
RDM1-630	630	G200004	1	13,64
RDM1-800	800	G200005	1	21,44
RDM1-1250	1250	G200006	1	37,04



MANUEL KURMA KOLU DÜŞÜK GERİLİM BOBİNİ

RDM1-100/225	100/225	G200101	1	37,04
RDM1-400/630	400/630	G200102	1	56,54
RDM1-800	800	G200103	1	74,09
RDM1-1250	1250	G200104	1	105,29
RDM1-100	100	G200201	1	27,29
RDM1-225	225	G200202	1	30,22
RDM1-400	400	G200203	1	42,90
RDM1-630	630	G200204	1	47,77
RDM1-800	800	G200205	1	58,49



Teknik Özellikler

RDM1

GENEL ÖZELLİKLER

- Standart: IEC / EN 60947-2
- Koruma sınıfı: IP20
- Elektrik oranı: AC 50/60Hz, AC 400-690V
- Ortam hava sıcaklığı: -5 ... + 40°C
- Bağıl nem: S90%
- Kirlilik derecesi: III
- Ürün, bariz sarsıntı, darbe veya titreşim olmayan bir yere kurulmalı ve çalıştırılmalıdır.

ELEKTRİKSEL ÖZELLİKLER

- Nominal yalıtım gerilimi Ui: 800V
- Nominal çalışma gerilimi Ue: 400/690V
- Devre Kesme Süresi : 0.5-2 sn.

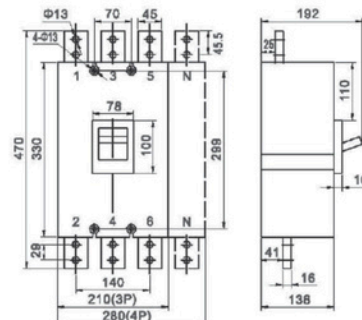
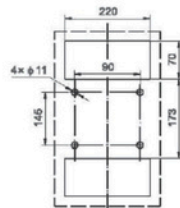
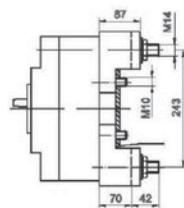

IEC/EN 60947-2

400-690V AC 50/60 Hz

Anma Akımı In(A)

Kesme Kapasitesi Icu (kA)

Sipariş Kodu

Kutu Adeti

Birim Fiyat (USD)

4 KUTUP

RDM1L Serisi	Anma Akımı In(A)	Kesme Kapasitesi Icu (kA)	Sipariş Kodu	Kutu Adeti	Birim Fiyat (USD)
RDM1L-125 Serisi	4P 63A	35	G115205		180,00
RDM1L-125 Serisi	4P 80A	35	G115206		184,00
RDM1L-125 Serisi	4P 100A	35	G115207		188,00
RDM1L-125 Serisi	4P 125A	35	G115208		192,00
RDM1L-250 Serisi	4P 160A	35	G115209		220,00
RDM1L-250 Serisi	4P 180A	35	G115210		225,00
RDM1L-250 Serisi	4P 200A	35	G115211		230,00
RDM1L-250 Serisi	4P 225A	35	G115212		235,00
RDM1L-250 Serisi	4P 250A	35	G115213		240,00
RDM1L-400 Serisi	4P 315A	35	G115214		500,00
RDM1L-400 Serisi	4P 350A	35	G115215		520,00
RDM1L-400 Serisi	4P 400A	50	G115216		540,00
RDM1L-800 Serisi	4P 500A	50	G115217		840,00
RDM1L-800 Serisi	4P 630A	50	G115218		860,00
RDM1L-800 Serisi	4P 700A	50	G115219		950,00
RDM1L-800 Serisi	4P 800A	50	G115220		990,00



Teknik Özellikler

RDM1L

GENEL ÖZELLİKLER

- Standart: IEC / EN 60947-2
- Koruma sınıfı: IP20
- Elektrik oranı: AC 50/60Hz, AC 400
- Ortam hava sıcaklığı: -5 ... + 40°C
- Bağıl nem: S90%
- Kirlilik derecesi: III
- Ürün, bariz sarsıntı, darbe veya titreşim olmayan bir yere kurulmalı ve çalıştırılmalıdır.

ELEKTRİKSEL ÖZELLİKLER

- RDM1L/100L-RMD1L/225L : Kaçak Alarm Modülü Yoktur.
- Kısa DevreKesme Kapasitesi Im (A): 25%Icu
- Nominal çalışma gerilimi Ue: 400V
- Çalışma Rakımı : 2000mt
- Pano Pozisyon Durumu: Dikey, En Fazla 5 derece

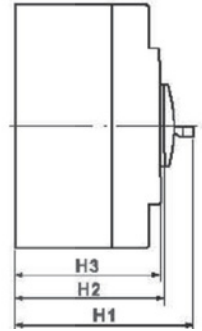
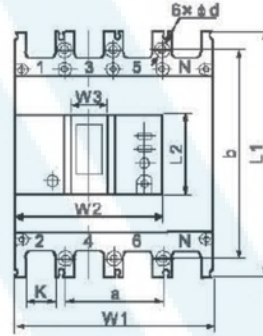

Teknik Özellikler

RDM11

GENEL ÖZELLİKLER

- Standart: IEC / EN 60947-2
- Koruma sınıfı: IP20
- Elektrik oranı: AC 50/60Hz, AC 400V
- Çalışma Akımı : 16-1600A
- Ortam hava sıcaklığı: -5 ... + 40°C
- Çalışma Rakımı : 2000mt
- Bağıl nem: S90%
- Kirlilik derecesi: III
- Ürün, bariz sarsıntı, darbe veya titreşim olmayan bir yere kurulmalı ve çalıştırılmalıdır.

ELEKTRİKSEL ÖZELLİKLER

- Nominal çalışma gerilimi AC3: 380- 690V
- Çalışma Servis Ömrü Kalıp Modeline göre:
RDM11-100 (Yüklü + Yüksüz) 10000
RDM11-160/250 (Yüklü + Yüksüz) 8000
RDM11-400/630 (Yüklü ve Yüksüz) 5000

RDM11-630H/3300 Ayar Sahalı Kompakt Şartelin Ayar Aralığı;

Ir

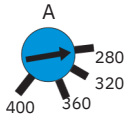

Im

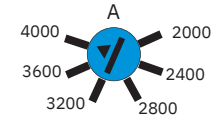

TM 400 D
400A/400

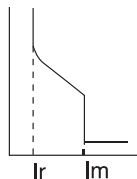

AKIM AYARI HESAPLAMASI

- 400x0,7=280A 280-400A Aralığında Ayarlanabilir.

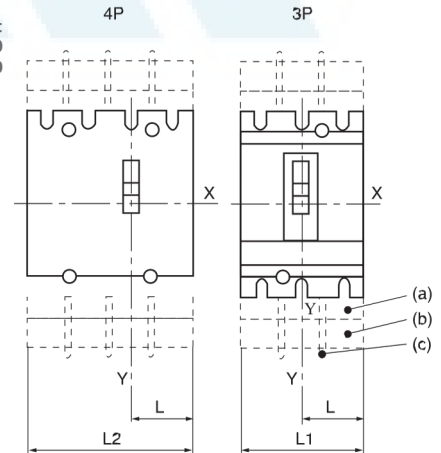

IEC/EN 60947-2 GB14048.2-2008
400 V AC 50/60 Hz

Kesme Kapasitesi Icu (kA)

Ayar Aralığı

Sipariş Kodu

Kutu Adeti

Birim Fiyat (USD)

3 KUTUP

Model	Polarite	Adet	Kesme Kapasitesi Icu (kA)	Ayar Aralığı	Sipariş Kodu	Kutu Adeti	Birim Fiyat (USD)
RDM11-100H/3300	3P	16A	50	11,2-16	G116101	1	126,00
RDM11-100H/3300	3P	20A	50	14-20	G116102	1	126,00
RDM11-100H/3300	3P	25A	50	17,5-25	G116103	1	126,00
RDM11-100H/3300	3P	32A	50	22,4-32	G116104	1	126,00
RDM11-100H/3300	3P	40A	50	28-40	G116105	1	145,00
RDM11-100H/3300	3P	50A	50	35-50	G116106	1	145,00
RDM11-100H/3300	3P	63A	50	44,1-63	G116107	1	145,00
RDM11-100H/3300	3P	80A	50	56-80	G116108	1	145,00
RDM11-100H/3300	3P	100A	50	70-100	G116109	1	145,00
RDM11-160H/3300	3P	125A	50	87,5-125	G116110	1	165,00
RDM11-160H/3300	3P	160A	50	112-160	G116111	1	168,00
RDM11-250H/3300	3P	200A	50	140-200	G116112	1	255,00
RDM11-250H/3300	3P	250A	50	175-250	G116113	1	260,00
RDM11-400H/3300	3P	315A	70	220,5-315	G116115	1	600,00
RDM11-400H/3300	3P	400A	70	280-400	G116116	1	620,00
RDM11-630H/3300	3P	500A	70	350-500	G116117	1	740,00
RDM11-630H/3300	3P	630A	70	441-630	G116118	1	835,00
RDM11-800H/3300	3P	800A	70	560-800	G116119	1	1970,00
RDM11-1000H/3300	3P	1000A	70	700-1000	G116120	1	2000,00
RDM11-1250H/3300	3P	1250A	70	875-1250	G116121	1	2450,00
RDM11-1600H/3300	3P	1600A	70	1120-1600	G116122	1	2670,00



4 KUTUP

Model	Polarite	Adet	Kesme Kapasitesi Icu (kA)	Ayar Aralığı	Sipariş Kodu	Kutu Adeti	Birim Fiyat (USD)
RDM11-100H/4300	4P	16A	50	11,2-16	G116201	1	190,00
RDM11-100H/4300	4P	20A	50	14-20	G116202	1	190,00
RDM11-100H/4300	4P	25A	50	17,5-25	G116203	1	190,00
RDM11-100H/4300	4P	32A	50	22,4-32	G116204	1	190,00
RDM11-100H/4300	4P	40A	50	28-40	G116205	1	190,00
RDM11-100H/4300	4P	50A	50	35-50	G116206	1	190,00
RDM11-100H/4300	4P	63A	50	44,1-63	G116207	1	190,00
RDM11-100H/4300	4P	80A	50	56-80	G116208	1	200,00
RDM11-100H/4300	4P	100A	50	70-100	G116209	1	215,00
RDM11-160H/4300	4P	125A	50	87,5-125	G116210	1	230,00
RDM11-160H/4300	4P	160A	50	112-160	G116211	1	260,00
RDM11-250H/4300	4P	200A	50	140-200	G116212	1	330,00
RDM11-250H/4300	4P	250A	50	175-250	G116213	1	347,00
RDM11-250H/4300	4P	315A	70	220,5-315	G116214	1	800,00
RDM11-400H/4300	4P	400A	70	280-400	G116215	1	900,00
RDM11-630H/4300	4P	500A	70	350-500	G116216	1	990,00
RDM11-630H/4300	4P	630A	70	441-630	G116217	1	1200,00
RDM11-800H/4300	4P	800A	70	560-800	G116218	1	2600,00
RDM11-1000H/4300	4P	1000A	70	700-1000	G116219	1	2900,00
RDM11-1250H/4300	4P	1250A	70	875-1250	G116220	1	3200,00
RDM11-1600H/4300	4P	1600A	70	1120-1600	G116221	1	3600,00



IEC/EN 60947-2
400-690 V AC 50/60 Hz

Anma Akımı In(A)

Sipariş Kodu

Kutu Adeti

Birim Fiyat
(USD)

3 KUTUP SABİT TİP

RDW1-1000	3P 630A	G118101	1	2850,00
RDW1-1000	3P 800A	G118102	1	2950,00
RDW1-1000	3P 1000A	G118103	1	3050,00
RDW1-2000	3P 1250A	G118121	1	3200,00
RDW1-2000	3P 1600A	G118122	1	3450,00
RDW1-2000	3P 2000A	G118123	1	3750,00
RDW1-3200	3P 2500A	G118141	1	4650,00
RDW1-3200	3P 3200A	G118142	1	5000,00
RDW1-4000	3P 4000A	G118161	1	9400,00
RDW1-6300	3P 5000A	G118181	1	16000,00
RDW1-6300	3P 6300A	G118182	1	20500,00



4 KUTUP SABİT TİP

RDW1-1000	4P 630A	G119101	1	3991,09
RDW1-1000	4P 800A	G119102	1	4052,53
RDW1-1000	4P 1000A	G119103	1	4334,94
RDW1-2000	4P 1250A	G119121	1	4175,35
RDW1-2000	4P 1600A	G119122	1	4175,35
RDW1-2000	4P 2000A	G119123	1	4420,97
RDW1-3200	4P 2500A	G119141	1	5649,00
RDW1-3200	4P 3200A	G119142	1	6140,17
RDW1-4000	4P 4000A	G119161	1	14736,42
RDW1-6300	4P 5000A	G119181	1	20876,66
RDW1-6300	4P 6300A	G119182	1	23820,60



3 KUTUP ÇEKMECELİ TİP

RDW1-1000	3P 630A	G120101	1	4519,19
RDW1-1000	3P 800A	G120102	1	4543,70
RDW1-1000	3P 1000A	G120103	1	4543,70
RDW1-2000	3P 1250A	G120121	1	4666,51
RDW1-2000	3P 1600A	G120122	1	4666,51
RDW1-2000	3P 2000A	G120123	1	5526,19
RDW1-3200	3P 2500A	G120141	1	7122,59
RDW1-3200	3P 3200A	G120142	1	7982,27
RDW1-4000	3P 4000A	G120161	1	12992,62
RDW1-6300	3P 5000A	G120181	1	20876,66
RDW1-6300	3P 6300A	G120182	1	23332,74



4 KUTUP ÇEKMECELİ TİP

RDW1-1000	4P 630A	G121101	1	5649,00
RDW1-1000	4P 800A	G121102	1	5771,74
RDW1-1000	4P 1000A	G121103	1	5833,19
RDW1-2000	4P 1250A	G121121	1	6017,36
RDW1-2000	4P 1600A	G121122	1	6017,36
RDW1-2000	4P 2000A	G121123	1	6877,04
RDW1-3200	4P 2500A	G121141	1	9210,30
RDW1-3200	4P 3200A	G121142	1	10438,33
RDW1-4000	4P 4000A	G121161	1	18420,52
RDW1-6300	4P 5000A	G121181	1	23332,74
RDW1-6300	4P 6300A	G121182	1	24560,77



***Fiyatlara açma kapama bobini ve motor aksesuarları dahildir.**



INNOVATIVE TECHNOLOGY LEADING THE ELECTRICITY

Teknolojide Üretimde İletimde Dağıtımda Kontrolde



IEC/EN 60898-1 220/440 V AC 50/60 Hz Anma Akımı In(A) Sipariş Kodu Kutu Adeti Birim Fiyat (USD)

DÜŞÜK VOLTAJ	RDW1 Serisi	1000A	G122101	1	210,58
	RDW1 Serisi	2000A	G122102	1	156,96
	RDW1 Serisi	3200A	G122103	1	156,96
	RDW1 Serisi	4000A	G122104	1	156,96
	RDW1 Serisi	6300A	G122105	1	210,58



MOTOR KORUMA	RDW1 Serisi	1000A	G122201	1	224,22
	RDW1 Serisi	2000A	G122202	1	207,65
	RDW1 Serisi	3200A	G122203	1	207,65
	RDW1 Serisi	4000A	G122204	1	207,65
	RDW1 Serisi	6300A	G122205	1	216,42

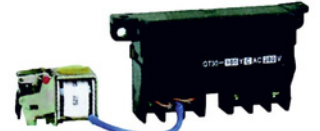

ELEKTROMAGNETİK KORUMA	RDW1 Serisi	1000A	G122301	1	107,23
	RDW1 Serisi	2000A	G122302	1	107,23
	RDW1 Serisi	3200A	G122303	1	107,23
	RDW1 Serisi	4000A	G122304	1	107,23
	RDW1 Serisi	6300A	G122305	1	107,23



Teknik Özellikler

RDW1

GENEL ÖZELLİKLER

- Standart: IEC / EN 60947
- Koruma sınıfı: IP20
- Elektrik oranı: AC 50/60Hz, AC 230-400V
- Ortam hava sıcaklığı: -5 ... + 40°C
- Bağıl nem: S90%
- Kirlilik derecesi : III
- Ürün, bariz sarsıntı, darbe veya titreşim olmayan bir yere kurulmalı ve çalıştırılmalıdır.

ELEKTRİKSEL ÖZELLİKLER

- İzolasyon Yalıtım Voltajı: 1000V
- Nominal çalışma gerilim Ue: 230/240V, 400/415V
- Elektrik Ömür: RDW1-1000 ~ 7000 Saat, RDW1-2000 ~ 6500 Saat, RDW1-3200 ~ 3000 Saat, RDW1-4000 ~ 3000 Saat, RDW1-6300 ~ 1500 Saat
- Mekanik Ömür: RDW1-1000 ~ 15000 Saat, RDW1-2000 ~ 15000 Saat, RDW1-3200 ~ 10000 Saat, RDW1-4000 ~ 10000 Saat, RDW1-6300 ~ 5000 Saat

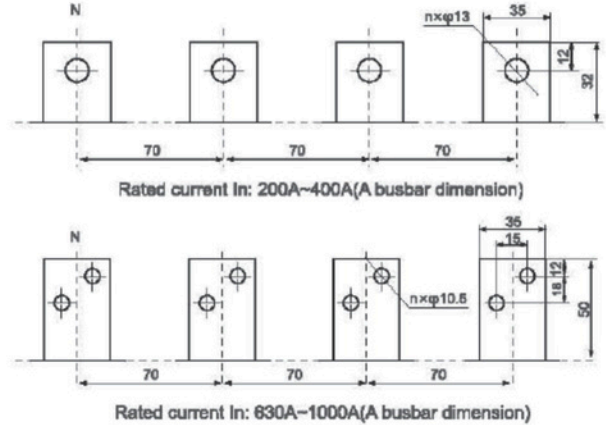
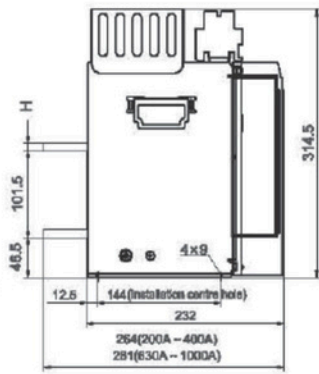
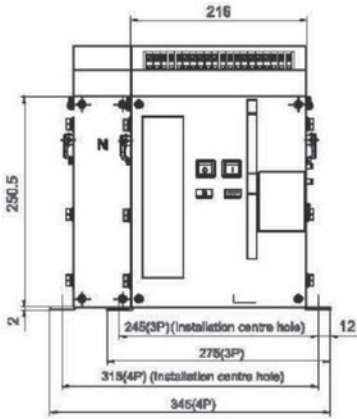

IEC/EN 60947-4-1
400/690 V AC 50 Hz

Anma Akımı In(A)

Sipariş Kodu

Kutu Adeti

Birim Fiyat
(USD)

3 KUTUP

RDC5-0610 3KW 1NA 220V/50Hz	6A	G130101	50	13,45
RDC5-0601 3KW 1NK 220V/50Hz	6A	G130102	50	13,45
RDC5-0910 4KW 1NA 220V/50Hz	9A	G130103	50	16,67
RDC5-0901 4KW 1NK 220V/50Hz	9A	G130104	50	16,67
RDC5-1210 5.5KW 1NA 220V/50Hz	12A	G130105	50	16,67
RDC5-1201 5.5KW 1NK 220V/50Hz	12A	G130106	50	16,67
RDC5-1810 7.5KW 1NA 220V/50Hz	18A	G130107	50	21,08
RDC5-1801 7.5KW 1NK 220V/50Hz	18A	G130108	50	21,08
RDC5-2510 11KW 1NA 220V/50Hz	25A	G130109	50	25,28
RDC5-2501 11KW 1NK 220V/50Hz	25A	G130110	50	25,28
RDC5-3210 15KW 1NA 220V/50Hz	32A	G130111	50	42,54
RDC5-3201 15KW 1NK 220V/50Hz	32A	G130112	50	42,54
RDC5-4011 18.5KW 1NA+1NK 220V/50Hz	40A	G130113	50	65,60
RDC5-5011 22KW 1NA+1NK 220V/50Hz	50A	G130114	50	69,75
RDC5-6511 30KW 1NA+1NK 220V/50Hz	65A	G130115	50	85,50
RDC5-8011 37KW 1NA+1NK 220V/50Hz	80A	G130116	50	135,94
RDC5-9511 45KW 1NA+1NK 220V/50Hz	95A	G130117	50	140,68



3 KUTUP

CJX2-F-115 55KW	115A	G131101	4	240,00
CJX2-F-150 75KW	150A	G131102	4	250,00
CJX2-F-185 90KW	185A	G131103	4	320,00
CJX2-F-225 110KW	225A	G131104	4	350,00
CJX2-F-265 132KW	265A	G131105	4	460,00
CJX2-F-330 160KW	330A	G131106	4	620,00
CJX2-F-400 200KW	400A	G131107	4	630,00
CJX2-F-500 250KW	500A	G131108	4	950,00
CJX2-F-630 335KW	630A	G131109	4	1300,00
CJX2-F-800 400KW	800A	G131110	4	1450,00
CJX2-F-1000 500KW	1000A	G131111	4	2270,00



Teknik Özellikler

RDC5

GENEL ÖZELLİKLER

- Standart: **IEC / EN 60947-4-1**
- Koruma sınıfı: **IP20**
- Elektrik oranı: **AC 50/60Hz, AC 400/660V**
- Ortam hava sıcaklığı: **-5 ... + 40°C**
- Bağıl nem: **S90%**
- Kirlilik derecesi : **III**
- Ürün, bariz sarsıntı, darbe veya titreşim olmayan bir yere kurulmalı ve çalıştırılmalıdır.

ELEKTRİKSEL ÖZELLİKLER

- Nominal çalışma gerilim U_e : **400/690V**
- Elektrik Ömür(100.000/Saat): **120**
- Mekanik Ömür(10.000/Saat): **1000**
- Çalışma Rakımı : **2000mt**
- Pano Pozisyon Durumu: **Dikey, En Fazla 5 derece**

Teknik Özellikler

CJX2-F

GENEL ÖZELLİKLER

- Standart: **IEC / EN 60947-4-1**
- Koruma sınıfı: **IP20**
- Elektrik oranı: **AC 50/60Hz, AC 400/660V**
- Ortam hava sıcaklığı: **-5 ... + 40°C**
- Bağıl nem: **S90%**
- Kirlilik derecesi : **III**
- Ürün, bariz sarsıntı, darbe veya titreşim olmayan bir yere kurulmalı ve çalıştırılmalıdır.

ELEKTRİKSEL ÖZELLİKLER

- Nominal çalışma gerilim U_e : **400/690V**
- Elektrik Ömür(100.000/Saat): **120**
- Mekanik Ömür(10.000/Saat): **1000**
- Çalışma Rakımı : **2000mt**
- Pano Pozisyon Durumu: **Dikey, En Fazla 5 derece**

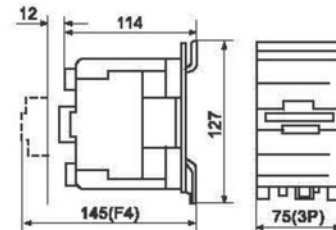
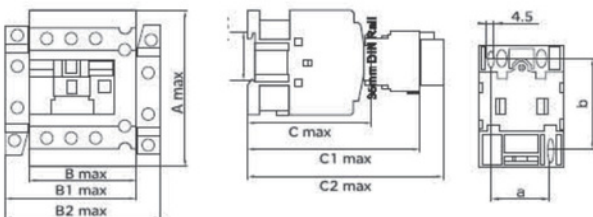

IEC/EN 60947-1-4
400/690 V AC 50 Hz

Anma Akımı In(A)

Sipariş Kodu

Kutu Adeti

Birim Fiyat
(USD)

3 KUTUP

CJX2-0910 4KW 1NA 220V/50Hz	9A	G132101	1	13,70
CJX2-0901 4KW 1NK 220V/50Hz	9A	G132102	1	13,70
CJX2-1210 5.5KW 1NA 220V/50Hz	12A	G132103	1	14,00
CJX2-1201 5.5KW 1NK 220V/50Hz	12A	G132104	1	14,00
CJX2-1810 7.5KW 1NA 220V/50Hz	18A	G132105	1	15,10
CJX2-1801 7.5KW 1NK 220V/50Hz	18A	G132106	1	15,10
CJX2-2510 11KW 1NA 220V/50Hz	25A	G132107	1	20,00
CJX2-2501 11KW 1NK 220V/50Hz	25A	G132108	1	20,00
CJX2-3210 15KW 1NA 220V/50Hz	32A	G132109	1	31,50
CJX2-3201 15KW 1NK 220V/50Hz	32A	G132110	1	31,50
CJX2-4011 18.5KW 1NA+1NK 220V/50Hz	40A	G132111	1	59,00
CJX2-5011 22KW 1NA+1NK 220V/50Hz	50A	G132112	1	68,00
CJX2-6511 30KW 1NA+1NK 220V/50Hz	65A	G132113	1	84,00
CJX2-8011 37KW 1NA+1NK 220V/50Hz	80A	G132114	1	103,00
CJX2-9511 45KW 1NA+1NK 220V/50Hz	95A	G132115	1	122,00



IEC/EN 60947-4-1
440/690 V AC 50/60 Hz

Sipariş Kodu

Güç Konağı

Kutu Adeti

Birim Fiyat
(USD)

(F4) YARDIMCI KONTAK (ÜSTE TAKILAN)

LA1-DN20	G200301	2NA	4	3,41
LA1-DN02	G200302	2NK	4	3,41
LA1-DN11	G200303	1NA+1NK	4	3,41
LA1-DN40	G200304	4NA	4	5,84
LA1-DN04	G200305	4NK	4	5,84
LA1-DN22	G200306	2NA+2NK	4	5,84
LA1-DN13	G200307	1NA+3NK	4	5,84
LA1-DN31	G200308	3NA+1NK	4	5,84



YANA TAKILAN

LA8-DN11 1NA+1N	G200401	1NA+1NK	1	15,60
LA8-DN20 K2NA	G200402	2NA	1	15,60



MEKANİK KİLİT

LA9 09-32	G200501	09/12/15/28/32 A220V AC	1	4,96
LA9 40-95	G200502	40/50/65/80/95 A220V AC	1	6,95

CJX2-F BOBİN

LX1-D2/110	G200601		4	6,34
LX1-D4/110	G200602		4	7,61
LX1-D6/110	G200603		4	10,52
LX1FF(F115/F150)	G200604		4	59,66
LX1FG(F185/F225)	G200605		4	87,74
LX1FH(F265/F330)	G200606		4	134,53
LX1FJ(F400)	G200607		4	216,42
LX1FK(F500)	G200608		4	256,20
LX1FL(F630/F800)	G200609		4	310,01



RDC5 YARDIMCI KONTAK

LX1-D2/110	G200701	220V AC	1	6,44
LX1-D4/110	G200702	220V AC	1	7,74
LX1-D6/110	G200703	220V AC	1	10,73

	IEC/EN 60947-4-1 400/690 V AC 50/60 Hz	Anma Akımı In(A)	Sipariş Kodu	Kutu Adeti	Birim Fiyat (USD)
220 VAC	CJX2-K 12105.5KW 1NA	12A	G170105	1	16,00
	CJX2-K 12015.5KW 1NK	12A	G170106	1	16,00
24 VAC	CJX2-K 12105.5KW 1NA	12A	G170105	1	16,00
	CJX2-K 12015.5KW 1NK	12A	G170106	1	16,00
24 VDC	CJX2-K 12105.5KW 1NA	12A	G170105	1	34,00
	CJX2-K 12015.5KW 1NK	12A	G170106	1	34,00



Teknik Özellikler

CJX2-K

GENEL ÖZELLİKLER

- Standart: **IEC / EN 60947-4-1**
- Koruma sınıfı: **IP20**
- Elektrik oranı: **AC 50/60Hz, AC 380V**
- Çalışma Akımı : **6-9-12A**
- Ortam hava sıcaklığı: **-5 ... + 40°C**
- Bağlı nem: **S90%**
- Kirillik derecesi : **III**
- Ürün, bariz sarsıntı, darbe veya titreşim olmayan bir yere kurulmalı ve çalıştırılmalıdır.

ELEKTRİKSEL ÖZELLİKLER

- Nominal çalışma gerilim AC3: **690V**
- Elektrik Ömür(10.000/Saat): **AC3-120**
- Mekanik Ömür(10.000/Saat): **1000**
- Çalışma Rakımı : **2000mt**
- Sigorta: **RDT16-16/RDT16-20**
- Bobin Gücü (VA): **4,5**

CJX2-K AKSESUAR

LA1-KN11	1NA+1NK	G170201	1	10,74
LA1-KN22	2NA+2NK	G170202	1	10,74



Teknik Özellikler

CJX2-K Aksesuar

GENEL ÖZELLİKLER

- Standart: **IEC / EN 60947-4-1**
- Koruma sınıfı: **IP20**
- Elektrik oranı: **AC 50/60Hz, AC 380V**
- Çalışma Akımı : **6-9-12A**
- Ortam hava sıcaklığı: **-5 ... + 40°C**
- Bağlı nem: **S90%**
- Kirillik derecesi : **III**
- Ürün, bariz sarsıntı, darbe veya titreşim olmayan bir yere kurulmalı

ELEKTRİKSEL ÖZELLİKLER

- Nominal çalışma gerilim AC3: **690V**
- Elektrik Ömür(106/Kez): **0.5-5**
- Mekanik Ömür(104/Kez): **1000**
- Çalışma Rakımı : **2000mt**

DC KONTAKTÖR

CJX2-0901Z	1NK 4Kw	24VDC	9A	G170001	1	35,00
CJX2-0910Z	1NA 4Kw	24VDC	9A	G170002	1	35,00
CJX2-1201Z	1NK 5.5Kw	24VDC	12A	G170003	1	36,00
CJX2-1210Z	1NA 5.5Kw	24VDC	12A	G170004	1	36,00
CJX2-1801Z	1NK 7.5Kw	24VDC	18A	G170005	1	38,00
CJX2-1810Z	1NA 7.5Kw	24VDC	18A	G170006	1	38,00
CJX2-2501Z	1NK 11Kw	24VDC	25A	G170007	1	61,00
CJX2-2510Z	1NA 11Kw	24VDC	25A	G170008	1	61,00
CJX2-3201Z	1NK 15Kw	24VDC	32A	G170009	1	65,00
CJX2-3210Z	1NA 15Kw	24VDC	32A	G170010	1	65,00
CJX2-4011Z	1NA+1NK 18.5Kw	24VDC	40A	G170011	1	135,00
CJX2-5011Z	1NA+1NK 22Kw	24VDC	50A	G170012	1	140,00
CJX2-6511Z	1NA+1NK 30Kw	24VDC	65A	G170013	1	155,00
CJX2-8011Z	1NA+1NK 37Kw	24VDC	80A	G170014	1	185,00
CJX2-9511Z	1NA+1NK 45Kw	24VDC	95A	G170015	1	200,00



Teknik Özellikler

CJX2-Z DC Kontaktör

GENEL ÖZELLİKLER

- Standart: **IEC / EN 60947-4-1**
- Koruma sınıfı: **IP20**
- Elektrik oranı: **AC 50/60Hz, AC 380-690V**
- Çalışma Akımı : **9-95A**
- Bağlı nem: **S90%**
- Kirillik derecesi : **III**
- Ürün, bariz sarsıntı, darbe veya titreşim olmayan bir yere kurulmalı

ELEKTRİKSEL ÖZELLİKLER

- Nominal çalışma gerilim AC3: **690V**
- Elektrik Ömür(104/Kez): **9-25A/100, 32-40A/80, 50-95A/60**
- Mekanik Ömür(104/Kez): **9-18A/1000, 25-95A/800**
- Bobin Voltajları: **DC24V, 48V, 110V, 220V**

IEC/EN 60947-6-1
380-400 V AC 50/60 Hz

Anma Akımı In(A)

Sipariş Kodu

Kutu Adeti

Birim Fiyat
(USD)

4 KUTUP

RDH5D-125	125A	G150111	1	168,00
RDH5D-160	160A	G150112	1	388,00
RDH5D-250	250A	G150116	1	432,00
RDH5D-400	400A	G150119	1	710,00
RDH5D-630	630A	G150121	1	782,00
RDH5D-1000	1000A	G150123	1	2376,00
RDH5D-1250	1250A	G150124	1	2544,00
RDH5D-1600	1600A	G150125	1	3274,00
RDH5D-2000	2000A	G150126	1	7455,00
RDH5D-2500	2500A	G150127	1	7580,00
RDH5D-3200	3200A	G150128	1	8592,00

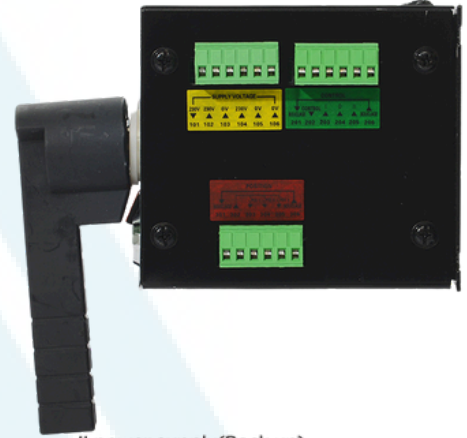

II power supply(Back up)

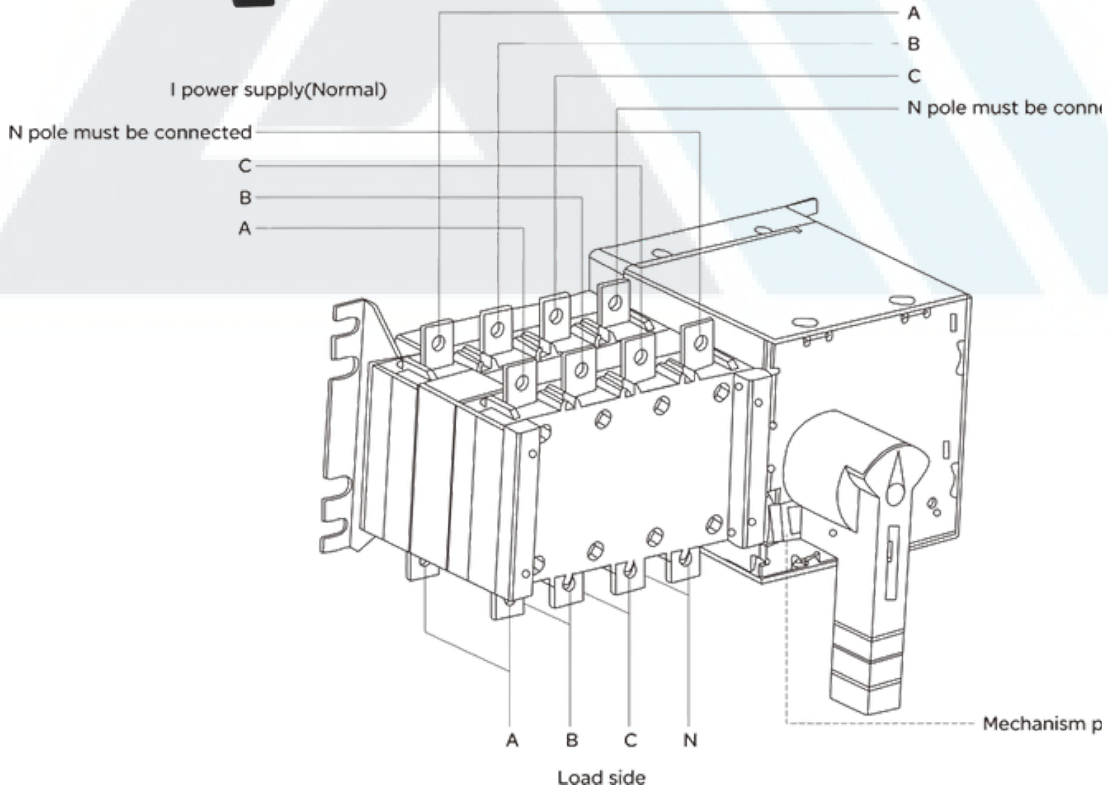

IEC/EN 60947-6-1
380 - 400 V AC 50/60 Hz

Anma Akımı In(A)

Sipariş Kodu

Kutu Adeti

Birim Fiyat
(USD)

RDQH-63L/4300	10A	G151101	1	580,00
RDQH-63L/4300	16A	G151102	1	580,00
RDQH-63L/4300	20A	G151103	1	580,00
RDQH-63L/4300	25A	G151104	1	580,00
RDQH-63L/4300	32A	G151105	1	580,00
RDQH-63L/4300	40A	G151106	1	580,00
RDQH-63L/4300	50A	G151107	1	580,00
RDQH-63L/4300	63A	G151108	1	580,00
RDQH-100L/4300	80A	G151109	1	605,00
RDQH-100L/4300	100A	G151110	1	605,00
RDQH-225L/4300	125A	G151111	1	758,00
RDQH-225L/4300	160A	G151112	1	758,00
RDQH-225L/4300	180A	G151113	1	758,00
RDQH-225L/4300	200A	G151114	1	758,00
RDQH-225L/4300	225A	G151115	1	758,00
RDQH-400L/4300	250A	G151116	1	1560,00
RDQH-400L/4300	315A	G151117	1	1560,00
RDQH-400L/4300	350A	G151118	1	1560,00
RDQH-400L/4300	400A	G151119	1	1560,00
RDQH-630L/4300	500A	G151120	1	1880,00
RDQH-630L/4300	630A	G151121	1	1880,00
RDQH-800L/4300	800A	G151122	1	3750,00
RDQH-800L/4300	1000A	G151123	1	3750,00
RDQH-800L/4300	1250A	G151124	1	3750,00
RDQH-800L/4300	1600A	G151125	1	3750,00
RDQH-1250L/4300	1000A	G151126	1	6540,00
RDQH-1250L/4300	1250A	G151127	1	6540,00
RDQH-1250L/4300	1600A	G151128	1	8990,00

4 KUTUP

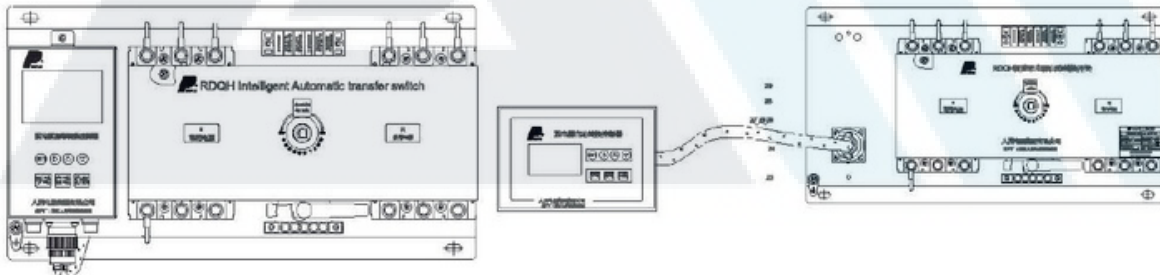

Teknik Özellikler

RDQH

GENEL ÖZELLİKLER

- Standart: IEC / EN 60947-6-1
- Koruma sınıfı: IP20
- Elektrik oranı: AC 50/60Hz, AC 380V
- Çalışma Akımı : 6-9-12A
- Ortam hava sıcaklığı: -5 ... + 40°C
- Bağlı nem: S90%
- Kirlilik derecesi : III
- Ürün, bariz sarsıntı, darbe veya titreşim olmayan bir yere kurulmalı

ELEKTRİKSEL ÖZELLİKLER

- Nominal çalışma gerilim AC3: 690V
- Switch Kontrol Voltajı : AC230V-AC400V
- Elektrik Ömür/Mekanik Ömür(<400A): 1500/4500
- Elektrik Ömür/Mekanik Ömür(≥400A): 1000/3000
- Çalışma Rakımı : 2000mt

IEC/EN 60947-4-1 / 60697-2
400-690 V AC 50/60 Hz

Anma Akımı Aralığı (A)

Sipariş Kodu

Kutu Adeti

Birim Fiyat
(USD)

PGV 2

Model	Anma Akımı Aralığı (A)	Sipariş Kodu	Kutu Adeti	Birim Fiyat (USD)
PGV2-M01	0,1-0,16A	G137101	50	33,00
PGV2-M02	0,16-0,25A	G137102	50	33,00
PGV2-M03	0,25-0,40A	G137103	50	33,00
PGV2-M04	0,40-0,63A	G137104	50	35,00
PGV2-M05	0,63-1A	G137105	50	35,00
PGV2-M06	1-1,6A	G137106	50	35,00
PGV2-M07	1,6-2,5A	G137107	50	35,00
PGV2-M08	2,5-4A	G137108	50	35,00
PGV2-M09	4-6,3A	G137109	50	36,00
PGV2-M10	6,3-10A	G137110	50	36,00
PGV2-M11	9-14A	G137111	50	36,00
PGV2-M12	13-18A	G137112	50	37,00
PGV2-M13	17-23A	G137113	50	38,00
PGV2-M14	20-25A	G137114	50	38,00
PGV2-M15	24-32A	G137115	50	55,00



PGV 2 YAR. KON.

Model	Anma Akımı (A)	Sipariş Kodu	Kutu Adeti	Birim Fiyat (USD)
PGV2-AN11 1 NO+1NC	6A	G139101	50	9,55
PGV2-AN20 2 NO	6A	G139102	50	9,55
PGV2-AE11 1 NO + 1NC	2,5A	G139103	50	6,62
PGV2-AE20 2 NO	2,5A	G139104	50	6,62

PGV 3

Model	Anma Akımı (A)	Sipariş Kodu	Kutu Adeti	Birim Fiyat (USD)
PGV3-M01	25-40A	G138201	50	110,00
PGV3-M02	40-63A	G138202	50	116,00
PGV3-M03	56-80A	G138203	50	155,00



PGV 3 YAR. KON.

Model	Anma Akımı (A)	Sipariş Kodu	Kutu Adeti	Birim Fiyat (USD)
PGV3-A01 1NA+1NK Yandan	6A	G139105	50	12,67
PGV3-A02 2NO Yandan	6A	G139106	50	12,67

Teknik Özellikler

PGV Serisi

GENEL ÖZELLİKLER

- Standart: IEC / EN 60947-4-1 IEC 60947-2
- Koruma sınıfı: IP20
- Elektrik oranı: AC 50/60Hz, AC 690V
- Ortam hava sıcaklığı: -5 ... + 40°C
- Bağıl nem: S90%
- Kirlilik derecesi : III
- Ürün, bariz sarsıntı, darbe veya titreşim olmayan bir yere kurulmalı ve çalıştırılmalıdır.

ELEKTRİKSEL ÖZELLİKLER

- Nominal yalıtım gerilim U : 690V
- Nominal çalışma gerilim Ue: 230/240V, 400/415V, 440V, 500V, 690V
- Nominal darbe dayanım gerilimi Uimp: 8000V -
- Nominal akım: PGV2 için 32A'e kadar; PGV3 için 80A'e kadar

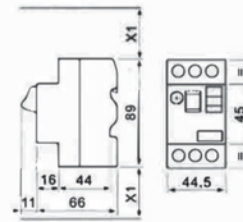

PGV2-M

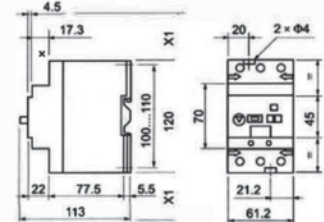

PGV3-M



INNOVATIVE TECHNOLOGY LEADING THE ELECTRICITY

Teknolojide Üretimde İletimde Dağıtımda Kontrolde

IEC/EN 60947-4-1
220/400 V AC 50/60 Hz

Sipariş Kodu

Kutu Adeti

Birim Fiyat
(USD)

DC KONTAKTÖR

RDC19-25/11B	12kVar	G155101	4	40,00
RDC19-32/11B	18kVar	G155102	4	52,00
RDC19-43/11B	20kVar	G155103	4	56,00
RDC19-63/21B	30kVar	G155104	4	108,00
RDC19-80/21B	40kVar	G155105	4	132,00
RDC19-95/21B	50kVar	G155106	4	152,00



Teknik Özellikler

RDC19

GENEL ÖZELLİKLER

- Standart: **IEC / EN 60947-4-1**
- Koruma sınıfı: **IP20**
- Elektrik oranı: **AC 50/60Hz, AC 220-380V**
- Çalışma Akımı : **17,23,29,43,58,72A**
- Ortam hava sıcaklığı: **-5 ... + 40°C**
- Bağıl nem: **S90%**
- Kirlilik derecesi : **III**
- Ürün, bariz sarsıntı, darbe veya titreşim olmayan bir yere kurulmalı ve çalıştırılmalıdır.
- Çalışma Rakımı : **2000mt**

ELEKTRİKSEL ÖZELLİKLER

- Nominal çalışma gerilim AC3: **690V** -
- Elektrik Ömür: **10000**
- Mekanik Ömür: **100000**
- Çalışma Frekansı : **120 (Kez/Saat)**

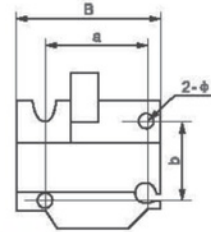
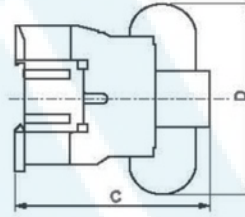
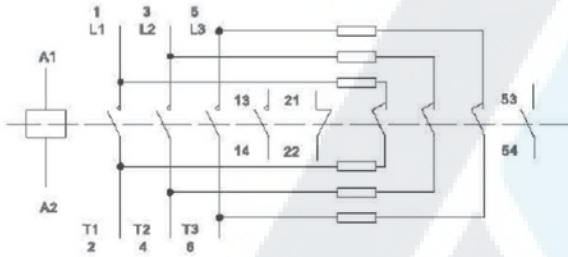

IEC/EN 61095
220 - 400 V AC 50/60 Hz

Sipariş Kodu

Kutu Adeti

Birim Fiyat
(USD)

DC KONTAKTÖR

RDCH8	2 Kutup 20A 2NA	G156101	4	17,00
RDCH8	4 Kutup 20A 4NA	G156102	4	30,00
RDCH8	2 Kutup 40A 2NA	G156103	4	30,00
RDCH8	4 Kutup 40A 4NA	G156104	4	41,00
RDCH8	2 Kutup 63A 2NA	G156105	4	30,00
RDCH8	4 Kutup 63A 4NA	G156106	4	41,00



Teknik Özellikler

RDCH8 Serisi

GENEL ÖZELLİKLER

- Standart: **IEC / EN 61095**
- Koruma sınıfı: **IP20**
- Elektrik oranı: **AC 50/60Hz, AC 230-400V**
- Ortam hava sıcaklığı: **-5 ... + 40°C**
- Bağıl nem: **S90%**
- Kirlilik derecesi : **III**
- Ürün, bariz sarsıntı, darbe veya titreşim olmayan bir yere kurulmalı ve çalıştırılmalıdır.

ELEKTRİKSEL ÖZELLİKLER

- Nominal Yalıtım Gerilim Ui: **400V**
- Nominal Çalışma Gerilim Ue: **230/400V**
- Güç Aralığı : **1-40 kW**
- Nominal Akım: **7-63A**
- Elektrik Ömür: **≥ 100000**
- Mekanik Ömür: **≥ 1000000**

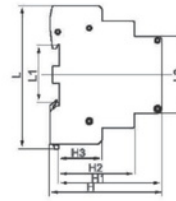

16/25 2P

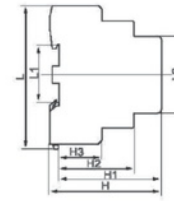

16/25 3P, 4P

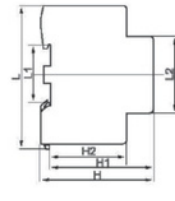

40/63 2P
40/63 3P, 4P

PAKO ŞALTER



IEC/EN 60947.3, CB1408.3
220/400 V AC 50/60 Hz

BOYUT

Sipariş Kodu

Kutu Adeti

Birim Fiyat
(USD)

Ürün Kodu	Boyut	Sipariş Kodu	Kutu Adeti	Birim Fiyat (USD)
LW26GS-20/02-1(1P)	48*48 OFF-ON 2P	G108500	1	11,00
LW26GS-20/02-2(1P)	64*64 OFF-ON 2P	G108501	1	12,00
LW26GS-25/02-1(1P)	48*48 OFF-ON 2P	G108502	1	15,00
LW26GS-25/02-2(1P)	64*64 OFF-ON 2P	G108503	1	17,00
LW26GS-32/02-2(1P)	64*64 OFF-ON 2P	G108504	1	22,00
LW26GS-63/02-2(1P)	64*64 OFF-ON 2P	G108505	1	32,00
LW26GS-20/04-1(3P)	48*48 OFF-ON 4P	G108506	1	14,00
LW26GS-20/04-2(3P)	64*64 OFF-ON 4P	G108507	1	16,00
LW26GS-25/04-1(3P)	48*48 OFF-ON 4P	G108508	1	20,00
LW26GS-25/04-2(3P)	64*64 OFF-ON 4P	G108509	1	23,00
LW26GS-32/04-2(3P)	64*64 OFF-ON 4P	G108510	1	29,00
LW26GS-63/04-2(3P)	64*64 OFF-ON 4P	G108511	1	61,00
LW26GS-125/04-3(3P)	88*88 OFF-ON 4P	G108512	1	76,00
LW26GS-160/04-3(3P)	88*88 OFF-ON 4P	G108513	1	114,00



Teknik Özellikler

LW26GS Serisi

GENEL ÖZELLİKLER

- Standart: **IEC / EN 60947.3 CB1408.3**
- Koruma sınıfı: **IP20**
- Elektrik oranı: **AC 50/60Hz, AC 220-440V**
- Çalışma Akımı : **20,25,32,63,125,160A**
- Ortam hava sıcaklığı: **-5 ... + 40°C**
- Bağıl nem: **S90%**
- Kirlilik derecesi : **III**
- Çalışma Rakımı : **2000mt**
- Nominal çalışma gerilimi AC3: **440V**

ÜRÜN ID	PLAKA KALIBI	Ebatlar(mm)				Montajlama(mm)			
		A	C	L	H	E	F	D1	D2
LW26GS-20	M1	□ 48	43	42	33	36	36	φ 8.5	φ 4.5
LW26GS-20	M2	□ 64	43	42	42	48	48	φ 8.5	φ 4.5
LW26GS-25	M1	□ 48	45.2	50	33	36	36	φ 8.5	φ 4.5
LW26GS-25	M2	□ 64	45.2	51	42	48	48	φ 8.5	φ 4.5
LW26GS-32	M2	□ 64	58	55	42	48	48	φ 10	φ 4.5
LW26GS-32	M3	□ 88	58	55	52	68	68	φ 13	φ 6
LW26GS-63	M2	□ 64	66	72.5	42	48	48	φ 10	φ 4.5
LW26GS-63	M3	□ 88	66	72.5	52	68	68	φ 13	φ 6
LW26GS-125	M3	□ 88	84	88	52	68	68	φ 13	φ 6
LW26GS-162	M3	□ 88	88	100	52	68	68	φ 13	φ 6

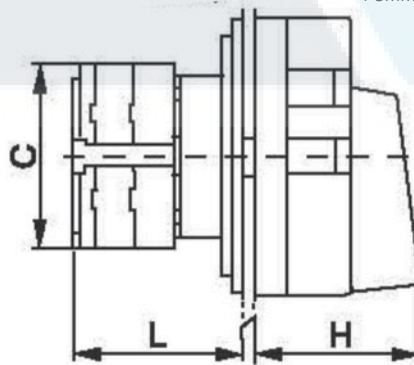
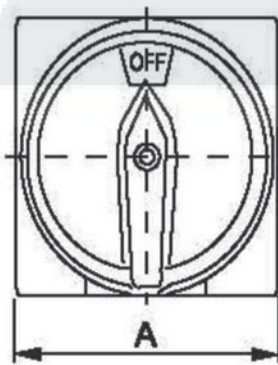

1-5mm Montaj Plaka Kalınlığı

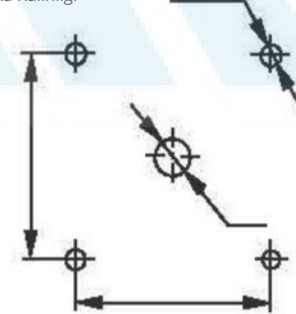

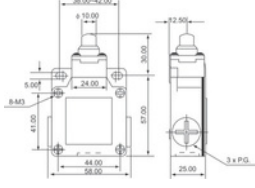

XCK-M110

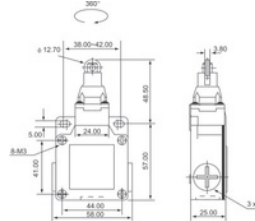

XCK-M102

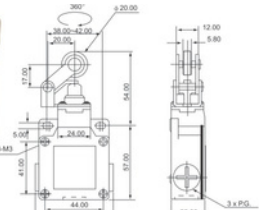

XCK-M121

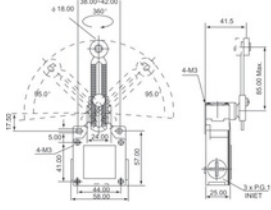

XCK-M141

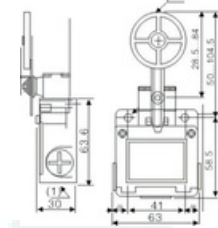

XCK-M139

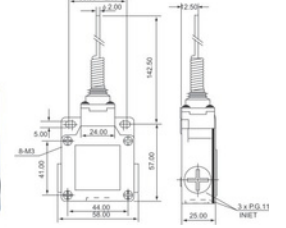

XCK-M106

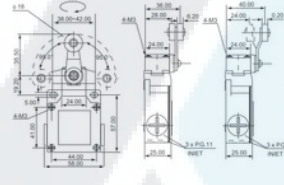

XCK-M115

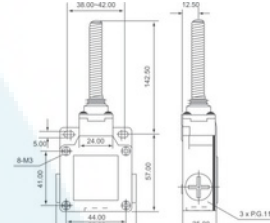

XCK-M108

Cenelec EN 50041,
EN50047, IEC337-1 VDE0660

Sipariş Kodu

Kutu Adeti

Birim Fiyat
(USD)

	Sipariş Kodu	Kutu Adeti	Birim Fiyat (USD)
XCK-M110	G108120	1	21,26
XCK-M102	G108121	1	21,26
XCK-M121	G108122	1	21,26
XCK-M115	G108123	1	21,26
XCK-M141	G108124	1	21,26
XCK-M106	G108125	1	21,26
XCK-M108	G108126	1	24,34
XCK-M139	G108129	1	24,34



Teknik Özellikler

XCK-M

GENEL ÖZELLİKLER

- Standart: Cenelec EN 50041, EN50047, IEC337-1 VDE0660
- Koruma sınıfı: IP66
- Elektrik oranı: 10A - 250VAC 6A-380VAC
- Ortam hava sıcaklığı: -5 ... + 65°C

- Bağlı nem: S95%
- Kirlilik derecesi : III
- Ürün, bariz sarsıntı, darbe veya titreşim olmayan bir yere kurulmalı ve çalıştırılmalıdır.

ELEKTRİKSEL ÖZELLİKLER

- Nominal çalışma gerilimi : 250V-380V
- Elektrik Ömür : 500000 Kez / 10A ve 250VAC Resistive
- Mekanik Ömür : 10.000.000 Kez (Belirlenen Şartlar Aralığında)
- İşlem Hızı : 5mm/sn'den 0,5mm/sn

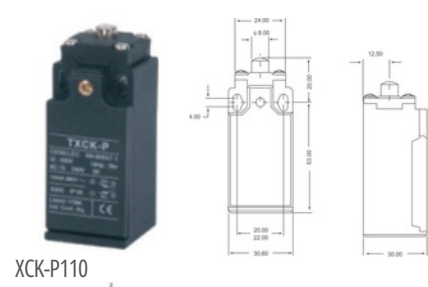

XCK-P110

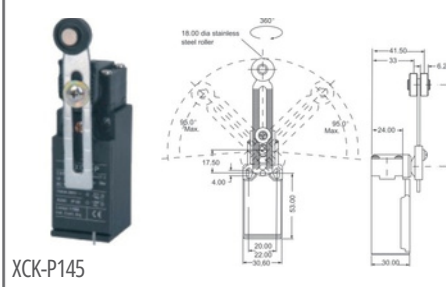

XCK-P145

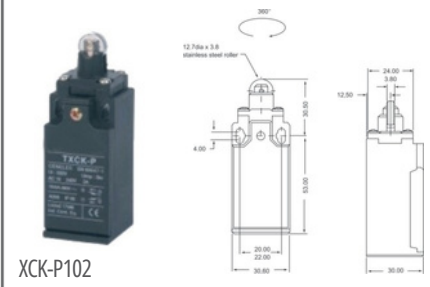

XCK-P102

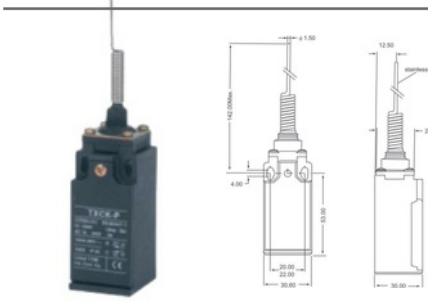

XCK-P106

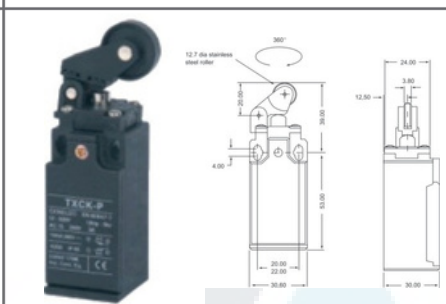

XCK-P128

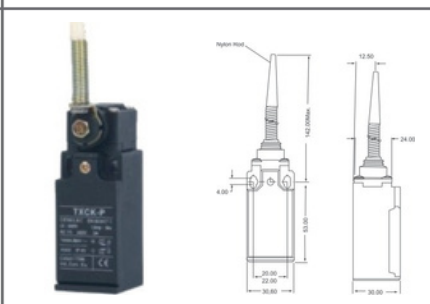

XCK-P181

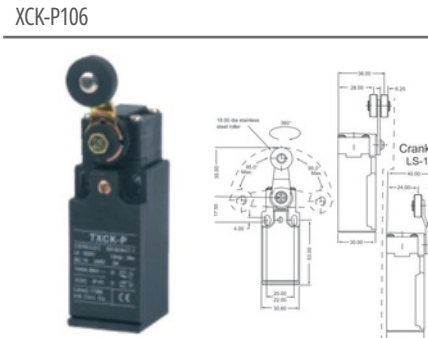

XCK-P118

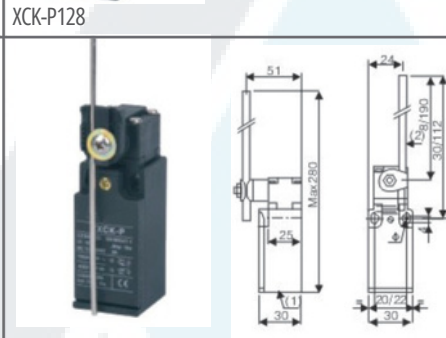

XCK-P155

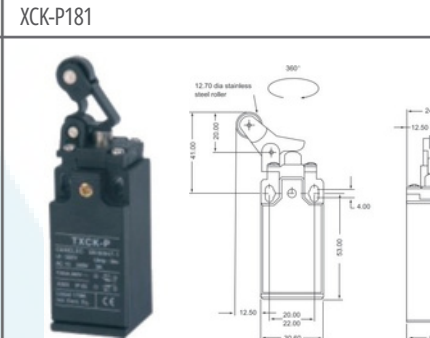

XCK-P127

Cenelec EN 50041,
EN50047, IEC337-1 VDE0660

Sipariş Kodu

Kutu Adeti

Birim Fiyat
(USD)

	Sipariş Kodu	Kutu Adeti	Birim Fiyat (USD)
XCK-P110	G108101	1	11,00
XCK-P145	G108102	1	11,00
XCK-P102	G108103	1	11,00
XCK-P106	G108104	1	11,00
XCK-P128	G108105	1	12,50
XCK-P181	G108106	1	11,00
XCK-P118	G108107	1	11,00
XCK-P155	G108108	1	11,00
XCK-P127	G108109	1	12,50
XCK-P139	G108110	1	12,50

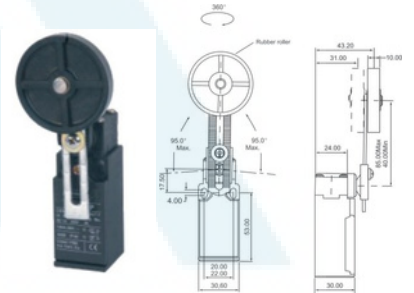

XCK-P139

Teknik Özellikler

XCK-P

GENEL ÖZELLİKLER

- Standart: **Cenelec EN 50041, EN50047, IEC337-1 VDE0660**
- Koruma sınıfı: **IP64**
- Elektrik oranı: **10A - 250VAC 6A-380VAC**
- Ortam hava sıcaklığı: **-5 ... + 65°C**

- Bağıl nem: **S95%**
- Kirlilik derecesi: **III**
- Ürün, bariz sarsıntı, darbe veya titreşim olmayan bir yere kurulmalı ve çalıştırılmalıdır.

ELEKTRİKSEL ÖZELLİKLER

- Nominal çalışma gerilim : **250V-380V**
- Elektrik Ömür : **50000 Kez / 10A ve 250VAC Resistive**
- Mekanik Ömür : **10.000.000 Kez (Belirlenen Şartlar Aralığında)**
- İşlem Hızı : **5mm/sn'den 0,5mm/sn**

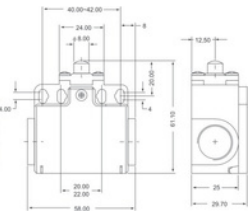

TXCK-T110

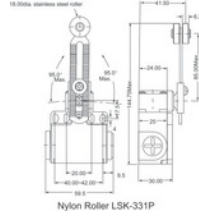

TXCK-T145

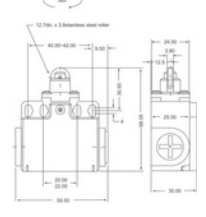

TXCK-T102

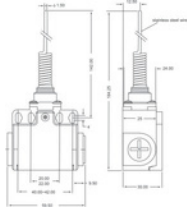

TXCK-T106

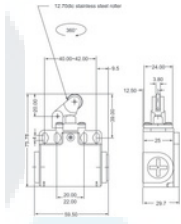

TXCK-T121

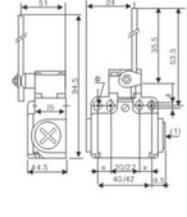

TXCK-T155

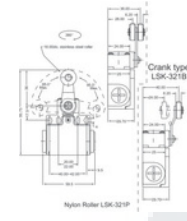

TXCK-T118

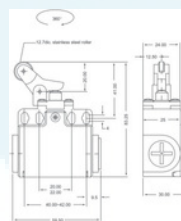

TXCK-T127

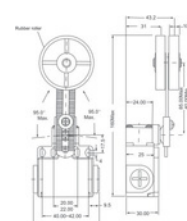

TXCK-T139

Cenelec EN 50041,
EN50047, IEC337-1 VDE0660

Sipariş Kodu

Kutu Adeti

Birim Fiyat
(USD)

	Sipariş Kodu	Kutu Adeti	Birim Fiyat (USD)
XCK-T110	G108111	1	14,00
XCK-T145	G108112	1	14,00
XCK-T102	G108113	1	14,00
XCK-T106	G108114	1	14,00
XCK-T121	G108115	1	14,00
XCK-T155	G108116	1	14,00
XCK-T118	G108117	1	14,00
XCK-T127	G108118	1	17,00
XCK-T139	G108119	1	17,00

T SERİSİ LİMİT SWITCH



Teknik Özellikler

XCK-T

GENEL ÖZELLİKLER

- Standart: **Cenelec EN 50041, EN50047, IEC337-1 VDE0660**
- Koruma sınıfı: **IP64**
- Elektrik oranı: **10A - 250VAC 6A-380VAC**
- Ortam hava sıcaklığı: **-5 ... + 65°C**

- Bağlı nem: **S95%**
- Kirlilik derecesi: **III**
- Ürün, bariz sarsıntı, darbe veya titreşim olmayan bir yere kurulmalı ve çalıştırılmalıdır.

ELEKTRİKSEL ÖZELLİKLER

- Nominal çalışma gerilim : **250V-380V**
- Elektrik Ömür : **500000 Kez / 10A ve 250VAC Resistive**
- Mekanik Ömür : **10.000.000 Kez (Belirlenen Şartlar Aralığında)**
- İşlem Hızı : **5mm/sn'den 0,5mm/sn**



V-15-1C25

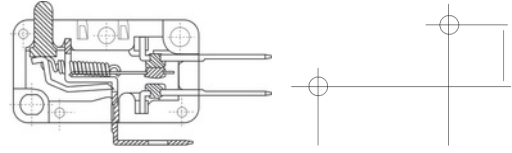
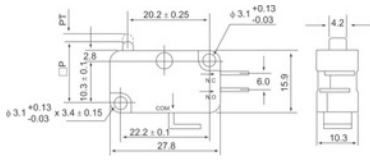

Teknik Çizim



V-151-1C25

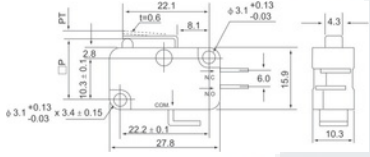

V-152-1C25

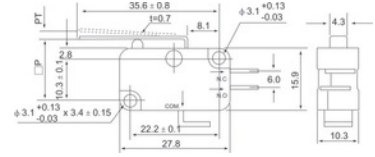

V-153-1C25

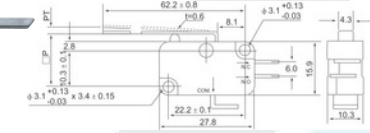

V-154-1C25

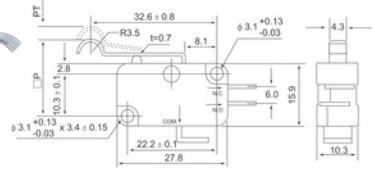

V-155-1C25

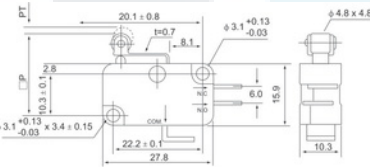

V-156-1C25

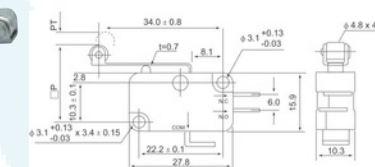

Cenelec EN 50041,
EN50047, IEC337-1 VDE0660

Sipariş Kodu

Kutu Adeti

Birim Fiyat
(USD)

V-15-1C25

G108300

1

1,40

V-151-1C25

G108301

1

1,40

V-152-1C25

G108302

1

1,40

V-153-1C25

G108303

1

1,40

V-154-1C25

G108304

1

1,40

V-155-1C25

G108305

1

1,40

V-156-1C25

G108306

1

1,40



Teknik Özellikler

V15 Micro Switch

GENEL ÖZELLİKLER

- Standart: Cenelec EN 50041, EN50047, IEC337-1 VDE0660
- Koruma sınıfı: IP64
- Elektrik oranı: 15A - 250VAC, 0.6A-125 VDC, 0.3A-250 VDC
- Ortam hava sıcaklığı: -5 ... + 65°C

- Bağıl nem: S95%
- Kirlilik derecesi : III

ELEKTRİKSEL ÖZELLİKLER

- Nominal çalışma gerilim : 15A - 250VAC, 0.6A-125 VDC, 0.3A-250 VDC
- Elektrik Ömür : 100.000 Kez
- Mekanik Ömür : 10.000.000 Kez (Belirlenen Şartlar Aralığında)



CM-1701

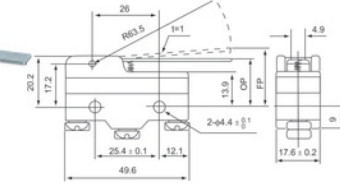

CM-1702

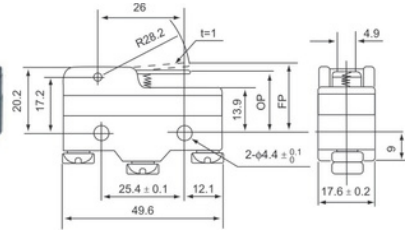

CM-1703

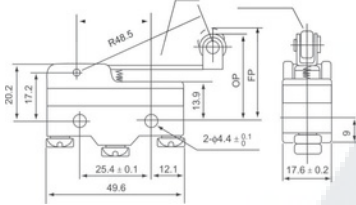

CM-1704

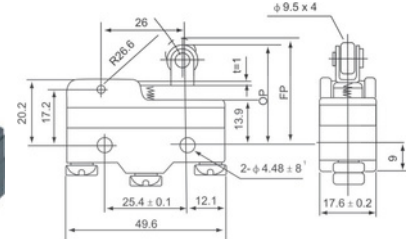

CM-1743

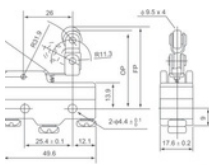

CM-1705

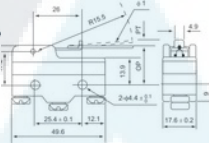

CM-1306

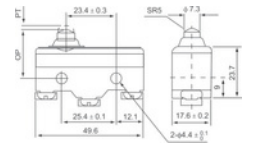

CM-1307

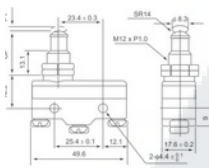

CM-1308

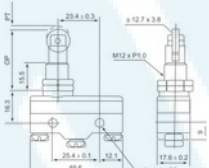

CM-1309

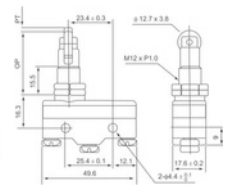

CM-1300

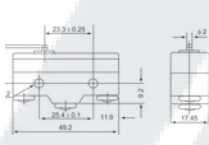

CM-1301

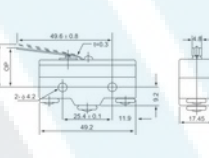

CM-1303

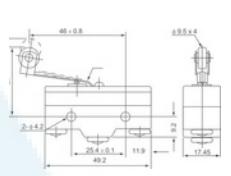

CM-1305

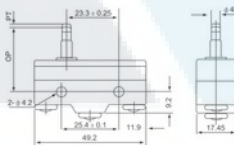

Cenelec EN 50041,
EN50047, IEC337-1 VDE0660

Sipariş Kodu

Kutu Adeti

Birim Fiyat
(USD)

CM SERİSİ LİMİT SWITCH

Model	Sipariş Kodu	Kutu Adeti	Birim Fiyat (USD)
CM1701	G108200	1	4,50
CM1702	G108201	1	4,50
CM1703	G108202	1	4,50
CM1704	G108203	1	4,50
CM1743	G108204	1	5,00
CM1705	G108205	1	4,50
CM1300	G108206	1	4,50
CM1301	G108207	1	4,50
CM1303	G108208	1	4,50
CM1305	G108209	1	4,50
CM1306	G108210	1	4,50
CM1307	G108211	1	5,00
CM1308	G108212	1	5,00
CM1309	G108213	1	5,00

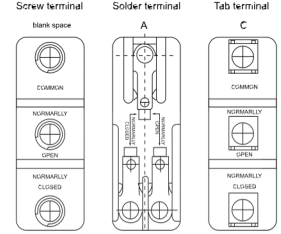

Teknik Özellikler

CM SERİSİ

GENEL ÖZELLİKLER

- OF: Operating Force: Uygulama Gücü** Switch Kontaklı Hareketi İçin Gerekli Güç-force
RF: Releasing Force: Serbest Bırakma Gücü Switch Kontaklı Geri Normal Haline Getirme Gerekli Güç (geri Pozisyona Getirme Gücü)
TT: Total Force: Toplam Uygulama Gücü Serbest Pozisyondan Sınırlı Pozisyona Getirmek İçin Gerekli Güç
FP: Free Position: Serbest Uygulama Pozisyon Uygulama Kolunun İlk Pozisyonu
OP: operation Position: Uygulama Pozisyonu Hızlı Hareketi Halinde Uygulama Kolunun İşlem Pozisyonu
RP: releasing Position: Geri Geliş Pozisyonu Uygulama Kolunun Hızlı Hareketinden Geri Normal Pozisyona Gelmesi
TTP: Total Travel Position: Toplam Kısa Mesafe Pozisyonu Uygulama Kolunun Sınırlı Pozisyona Ulaşma Durumu
PT: Pretravel: Sınırlı Ön Mesafe Pozisyonu ilk Pozisyondan Hareketli Pozisyona Geçişteki Mesafe Yada Açık
OT: Overtravel : Sınırlı Ön Mesafeyi Aşan Pozisyon Uygulama Kolunun Aksiyon Pozisyonu Aşan Mesafe Yada Açık
MD: Movement Differential: Hareket Aralığı Uygulama Kolunun İleri Ve Geri Mesafe Yada Açık
TT: Total Travel: Toplam Hareket Aralığı Uygulama Kolunun En İleri Yada En Geri Arasındaki Mesafe Yada Açık

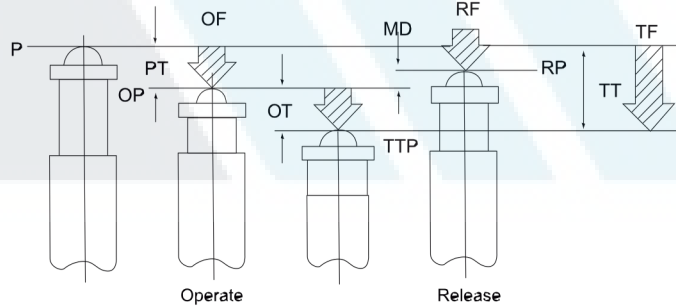
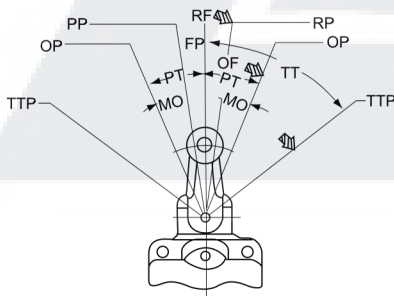



C011B/C012B/C013B

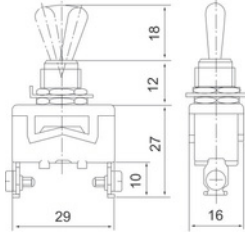

C021B/C022B/C023B

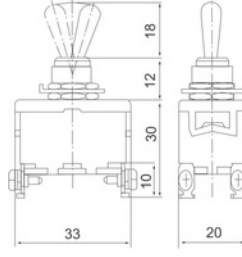

C511B/C512B/C513B

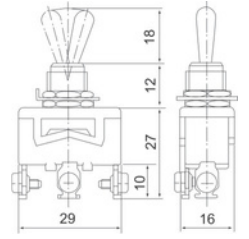

KORUMA KILIFI

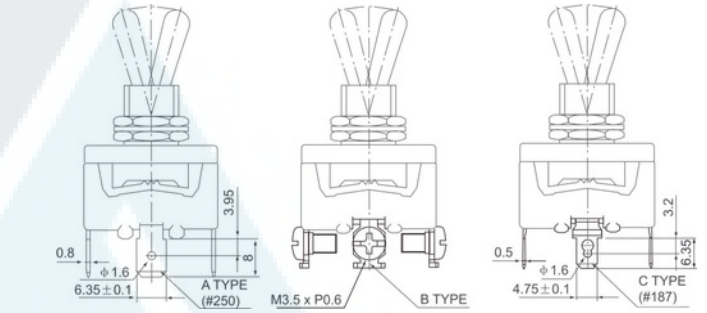
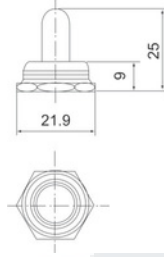

KLEMENS TİPİ

IEC/EN 60898-1 220/400 V AC 50/60 Hz

Sipariş Kodu

Kutu Adeti

Birim Fiyat (USD)

Model	Sipariş Kodu	Kutu Adeti	Birim Fiyat (USD)
C011A/C012A/C013A	G108400	1	3,04
C021A/C022A/C023A	G108402	1	3,54
C021B/C022B/C023B	G108403	1	2,70
C511A/C512A/C513A	G108404	1	3,38
C511B/C512B/C513B	G108405	1	2,53
C521A/C522A/C523A	G108406	1	3,89
C521B/C522B/C523B	G108407	1	3,04



Teknik Özellikler

Toggle Switch

GENEL ÖZELLİKLER

- Elektrik oranı: **10A/15A - 250VAC**
- Ortam hava sıcaklığı: **-25 ... + 80°C**
- Elektrik Ömür : **Min. 100.000 Kez**
- Mekanik Ömür : **Min. 500.000 Kez**
- Bağlı nem: **S85%**
- Kirlilik derecesi : **III**

TERMİNAL TİPLERİ

A	Tab Klemens
B	V dalı Klemens
C	Leh ml Klemens

ELEKTRİKSEL ÖZELLİKLER

Yük	Type	AC	DC
Direnç	C0	10A 250V 15A 125V	0.4A 250V 0.8A 125V
	C5	15A 250V 20A 125V	0.5A 250V 0.9A 125V
Endüktif	C0	10A 250V 15A 250V	0.2A 250V 0.4A 125V
	C5	15A 250V 20A 125V	0.3A 250V 0.5A 125V 15A 30V
Lamba	C0	300W 100V 500W 200V	-
	C5	400W 125V 800W 250V	7A 30V
	C0	200W 125V 300W 250V	-
Motor	C5	400W 125V(single phase)	-
	C0	550W 250V(three phase)	-
	C5	750W 250V(three phase)	-



SFMS-1

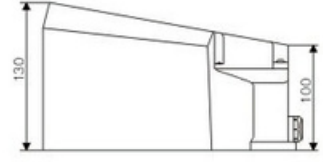
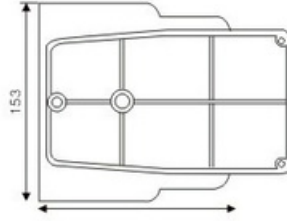

FS-1

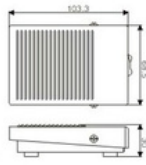

FS-01

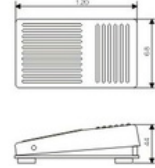

FS-101

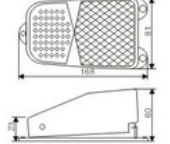

YDT1-101

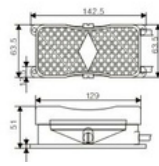

	PEDAL SWITCH	Sipariş Kodu	Kutu Adeti	Birim Fiyat (USD)
FS SERİSİ	SFMS-1	G108000	1	45,00
	FS-1	G108001	1	9,50
	FS-01	G108002	1	7,50
	YDT1-101	G108003	1	32,00
	FS-101	G108004	1	11,50

- Standart: IEC337-1 GB14048.5-2001 - Elektrik oranı: AC380V- DC220V 3-21A



INNOVATIVE TECHNOLOGY LEADING THE ELECTRICITY

Teknolojide Üretimde İletimde Dağıtımda Kontrolde

PLASTİK YAYLI DÜZ

	Sipariş Kodu	Kutu Adeti	Birim Fiyat (USD)
PXB2-EA121 SİYAH-NO	G107030	10	1,40
PXB2-EA131 YEŞİL-NO	G107031	10	1,40
PXB2-EA142 KIRMIZI-NC	G107032	10	1,40
PXB2-EA151 SARI-NO	G107033	10	1,40
PXB2-EA161 MAVİ-NO	G107034	10	1,40

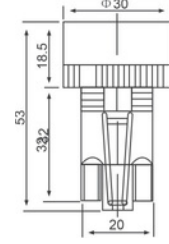

PLASTİK YAYLI DÜZ

	Sipariş Kodu	Kutu Adeti	Birim Fiyat (USD)
PXB2-EA125 SİYAH-NO+NC	G107035	10	1,60
PXB2-EA135 YEŞİL-NO+NC	G107036	10	1,60
PXB2-EA145 KIRMIZI-NO+NC	G107037	10	1,60
PXB2-EA155 SARI-NO+NC	G107038	10	1,60
PXB2-EA165 MAVİ-NO+NC	G107039	10	1,60

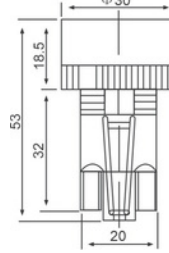

PLASTİK YAYLI DÜZ

	Sipariş Kodu	Kutu Adeti	Birim Fiyat (USD)
PXB5-AA11 BEYAZ-NO	G107040	10	2,50
PXB5-AA21 SİYAH-NO	G107041	10	2,50
PXB5-AA31 YEŞİL-NO	G107042	10	2,50
PXB5-AA42 KIRMIZI-NC	G107043	10	2,50
PXB5-AA51 SARI-NO	G107044	10	2,50
PXB5-AA61 MAVİ-NO	G107045	10	2,50

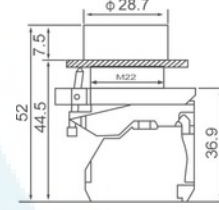

LEDLİ YAYLI DÜZ 24 V

	Sipariş Kodu	Kutu Adeti	Birim Fiyat (USD)
PXB5-AW31B1 BEYAZ-NO	G107091	10	8,00
PXB5-AW33B1 YEŞİL-NO	G107092	10	8,00
PXB5-AW34B2 KIRMIZI-NC	G107093	10	8,00
PXB5-AW35B1 SARI-NO	G107094	10	8,00
PXB5-AW36B1 MAVİ-NO	G107095	10	8,00

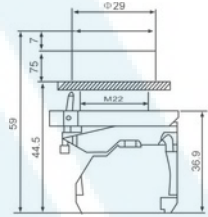

LEDLİ YAYLI DÜZ 220V

	Sipariş Kodu	Kutu Adeti	Birim Fiyat (USD)
PXB5-AW3161 BEYAZ-NO	G107086	10	8,00
PXB5-AW3361 YEŞİL-NO	G107087	10	8,00
PXB5-AW3461 KIRMIZI-NC	G107088	10	8,00
PXB5-AW3561 SARI-NO	G107089	10	8,00
PXB5-AW3661 MAVİ-NO	G107090	10	8,00

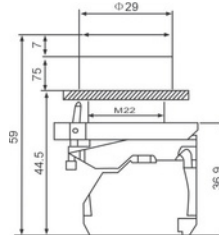

İŞIKLI MANDAL BUTON 24-220V 0-1

	Sipariş Kodu	Kutu Adeti	Birim Fiyat (USD)
PXB5-AK21 NO 24VDC Green	24V NO ● 0-1 G107062	Kalıcı 10	5,60
PXB5-AK21 NO 24VDC Red	24V NO ● 0-1 G107063	Kalıcı 10	5,60
PXB5-AK21 NO 24VDC Yellow	24V NO ● 0-1 G107064	Kalıcı 10	5,60
PXB5-AK21 NO 220VAC Green	220V NO ● 0-1 G107065	Kalıcı 10	5,60
PXB5-AK21 NO 220VAC Red	220V NO ● 0-1 G107066	Kalıcı 10	5,60
PXB5-AK21 NO 220VAC Yellow	220V NO ● 0-1 G107067	Kalıcı 10	5,60

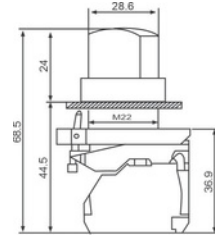

İŞIKLI MANDAL BUTON 24-220V 1-0-2

	Sipariş Kodu	Kutu Adeti	Birim Fiyat (USD)
PXB5-AK33 NO+NO 24VDC Green	24V 2NO ● 1-0-2 G107099	Kalıcı 10	6,20
PXB5-AK33 NO+NO 24VDC Red	24V 2NO ● 1-0-2 G107100	Kalıcı 10	6,20
PXB5-AK33 NO+NO 24VDC Yellow	24V 2NO ● 1-0-2 G107101	Kalıcı 10	6,20
PXB5-AK33 NO+NO 220VAC Green	220V 2NO ● 1-0-2 G107102	Kalıcı 10	6,20
PXB5-AK33 NO+NO 220VAC Red	220V 2NO ● 1-0-2 G107103	Kalıcı 10	6,20
PXB5-AK33 NO+NO 220VAC Yellow	220V 2NO ● 1-0-2 G107104	Kalıcı 10	6,20

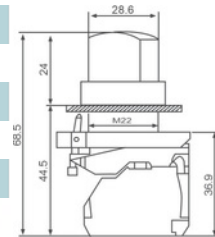

MANDAL BUTON

	Sipariş Kodu	Kutu Adeti	Birim Fiyat (USD)
PXB5-AD21 N/O	● G107058	Kalıcı 10	2,80
PXB5-AD41 N/O	● G107059	Yaylı 10	3,00

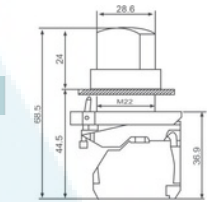

MANDAL BUTON

	Sipariş Kodu	Kutu Adeti	Birim Fiyat (USD)
PXB5-AD33 N/O+N/O	● G107060	Kalıcı 10	3,60
PXB5-AD53 N/O+N/O	● G107061	Yaylı 10	3,80

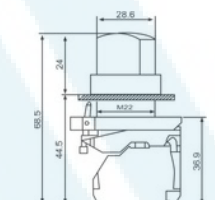

ANAHTARLI MANDAL BUTON

	Sipariş Kodu	Kutu Adeti	Birim Fiyat (USD)
PXB5-AG21 N/O	● G107082	Kalıcı 10	4,60
PXB5-AG61 N/O	● G107083	Yaylı 10	4,80

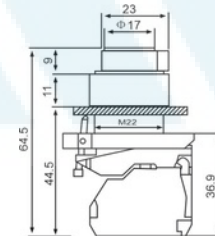

ANAHTARLI MANDAL BUTON

	Sipariş Kodu	Kutu Adeti	Birim Fiyat (USD)
PXB5-AG33 N/O+N/O	● G107084	Kalıcı 10	5,40
PXB5-AG53 N/O+N/O	● G107085	Yaylı 10	5,60

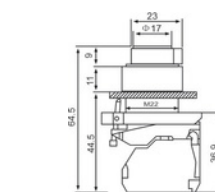

Model	Özellikler	Sipariş Kodu	Kutu Adeti	Birim Fiyat (USD)	Boyutlar	Görünüm
PXB5-AL8325	YEŞİL-KIRMIZI İKİZ DÜZ N/O+N/C	G107078	10	4,60	47,6 x 27,6 44,5 36,9	
PXB5-AW83M5	YEŞİL KIRMIZI IŞIKLI İKİZ DÜZ 220V N/O+N/C	G107056	10	8,20	47,6 x 27,6 44,5 36,9	
PXB5-AW8465	YEŞİL KIRMIZI IŞIKLI İKİZ ÇIKIK 220V N/O+N/C	G107056	10	8,20	47,6 x 27,6 44,5 36,9	
PXB5-AW84B5	İKİZ ÇIKIK IŞIKLI 24V N/O+N/C	G107080	10	8,00	47,6 x 27,6 44,5 36,9	
PXB5-AW83B5	İKİZ DÜZ IŞIKLI 24V DC N/O	G107081	10	8,00	47,6 x 27,6 44,5 36,9	
PXB5-AC31	MANTAR BAŞLI KAYICI START N/O	G107076	10	4,50	47,6 x 27,6 44,5 36,9	
PXB5-AC42	ACİL TİP MANTAR BAŞLI KAYICI STOP N/C	G107074	10	4,50	47,6 x 27,6 44,5 36,9	
PXB5-AS542	ACİL TİP MANTAR BAŞLI KALICI STOP N/C	G107098	10	4,90	47,6 x 27,6 44,5 36,9	

İŞARETLİ YAYLI

Sipariş Kodu	Kutu Adeti	Birim Fiyat (USD)
PXB5-AA3311 N/O	10	2,30

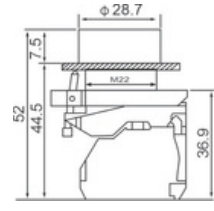

İŞARETLİ YAYLI

Sipariş Kodu	Kutu Adeti	Birim Fiyat (USD)
PXB5-AA4322 KIRMIZI-NC / 0	10	2,30

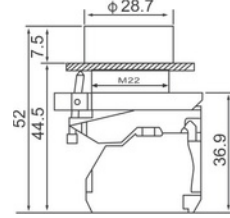

İŞARETLİ SİYAH BEYAZ YAYLI

Sipariş Kodu	Kutu Adeti	Birim Fiyat (USD)
PXB5-AA3341 BEYAZ - N/O	10	2,30
PXB5-AA3351 SİYAH - N/O	10	2,30

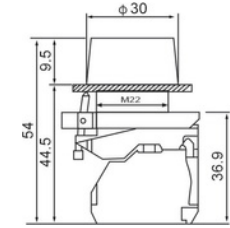

İYAYLI ÇIKIK KAFA



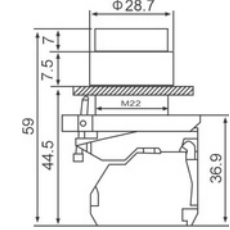





Sipariş Kodu	Kutu Adeti	Birim Fiyat (USD)
PXB5-AL11 BEYAZ-NO	10	2,30
PXB5-AL21 SİYAH-NO	10	2,30
PXB5-AL31 YEŞİL-NO	10	2,30
PXB5-AL42 KIRMIZI-NC	10	2,30
PXB5-AL51 SARI-NO	10	2,30
PXB5-AL61 MAVİ-NO	10	2,30









LAYS YARDIMCI KONTAK

Sipariş Kodu	Kutu Adeti	Birim Fiyat (USD)
AE101 N/O	10	1,00
AE102 N/C	10	1,00



 <p>TÜRK STANDARDLARI ENSTİTÜSÜ TÜRK STANDARDLARINA UYGUNLUK BELGESİ TURKISH STANDARDS INSTITUTION CERTIFICATE OF CONFORMITY TO TURKISH STANDARDS</p> <p>Markanın Tescim / Registration of the Mark TSE  </p> <p>BELGE KAPSAMI (110438-TSE-0101nolu belgenin ihracat için kullanılması) EXPORT CORP İLGİLİ TÜRK STANDARDI/RELATED TURKISH STANDARD TS 5018-1 EN 60988-1A/11 / 12.06.2013 - TS 5018-1 EN 60988-1A/11 / 09.03.2006</p> <p>Belge Sahibi Kuruluşun Adı PEOPLE ELE APPLIANCE GROUP ZHEJIANG IMPORT & EXPORT CORP</p> <p>Üretim Yeri Adı PEOPLE IND. ZONE, CHEZHAN ROAD 555, LUSHU, YUEQING, ZHEJIANG PROVINCE, CHINA YURTDIŞIÇIN</p> <p>İptal Edilen Belge Numarası (Varırsa) 14.41.01.00.00/TSE-65994</p> <p>Belge Kapsamı Model: RDB67-43</p>	 <p>TÜRK STANDARDLARI ENSTİTÜSÜ TÜRK STANDARDLARINA UYGUNLUK BELGESİ TURKISH STANDARDS INSTITUTION CERTIFICATE OF CONFORMITY TO TURKISH STANDARDS</p> <p>Markanın Tescim / Registration of the Mark TSE  </p> <p>BELGE KAPSAMI (110438-TSE-0101nolu belge devre dışı bırakılması) EXPORT CORP İLGİLİ TÜRK STANDARDI/RELATED TURKISH STANDARD TS 5018-1 EN 60988-1A/11 / 12.06.2013 - TS 5018-1 EN 60988-1A/11 / 09.03.2006</p> <p>Belge Sahibi Kuruluşun Adı PEOPLE ELE APPLIANCE GROUP ZHEJIANG IMPORT & EXPORT CORP</p> <p>Üretim Yeri Adı PEOPLE IND. ZONE, CHEZHAN ROAD 555, LUSHU, YUEQING, ZHEJIANG PROVINCE, CHINA YURTDIŞIÇIN</p> <p>İptal Edilen Belge Numarası (Varırsa) 14.41.01.00.00/TSE-65994</p> <p>Belge Kapsamı Model: RDB67-43</p>	 <p>TÜRK STANDARDLARI ENSTİTÜSÜ TÜRK STANDARDLARINA UYGUNLUK BELGESİ TURKISH STANDARDS INSTITUTION CERTIFICATE OF CONFORMITY TO TURKISH STANDARDS</p> <p>Markanın Tescim / Registration of the Mark TSE  </p> <p>BELGE KAPSAMI (110438-TSE-0101nolu belge devre dışı bırakılması) EXPORT CORP İLGİLİ TÜRK STANDARDI/RELATED TURKISH STANDARD TS 5018-1 EN 60988-1A/11 / 12.06.2013 - TS 5018-1 EN 60988-1A/11 / 09.03.2006</p> <p>Belge Sahibi Kuruluşun Adı PEOPLE ELE APPLIANCE GROUP ZHEJIANG IMPORT & EXPORT CORP</p> <p>Üretim Yeri Adı PEOPLE IND. ZONE, CHEZHAN ROAD 555, LUSHU, YUEQING, ZHEJIANG PROVINCE, CHINA YURTDIŞIÇIN</p> <p>İptal Edilen Belge Numarası (Varırsa) 14.41.01.00.00/TSE-65994</p> <p>Belge Kapsamı Model: RDB67-43</p>
---	--	---

 <p>TÜRK STANDARDLARI ENSTİTÜSÜ TÜRK STANDARDLARINA UYGUNLUK BELGESİ TURKISH STANDARDS INSTITUTION CERTIFICATE OF CONFORMITY TO TURKISH STANDARDS</p> <p>Markanın Tescim / Registration of the Mark TSE  </p> <p>BELGE KAPSAMI (110438-TSE-0401nolu belge devamsı) PEOPLE ELE APPLIANCE GROUP İLGİLİ TÜRK STANDARDI/RELATED TURKISH STANDARD TS 5018-1 EN 60988-1A/11 / 12.06.2013 - TS 5018-1 EN 60988-1A/11 / 09.03.2006</p> <p>Belge Sahibi Kuruluşun Adı PEOPLE ELE APPLIANCE GROUP ZHEJIANG IMPORT & EXPORT CORP</p> <p>Üretim Yeri Adı PEOPLE IND. ZONE, CHEZHAN ROAD 555, LUSHU, YUEQING, ZHEJIANG PROVINCE, CHINA YURTDIŞIÇIN</p> <p>İptal Edilen Belge Numarası (Varırsa) 14.41.01.00.00/TSE-65994</p> <p>Belge Kapsamı Model: RDB67-43</p>	 <p>TÜRK STANDARDLARI ENSTİTÜSÜ TÜRK STANDARDLARINA UYGUNLUK BELGESİ TURKISH STANDARDS INSTITUTION CERTIFICATE OF CONFORMITY TO TURKISH STANDARDS</p> <p>Markanın Tescim / Registration of the Mark TSE  </p> <p>BELGE KAPSAMI (110438-TSE-0401nolu belge devamsı) PEOPLE ELE APPLIANCE GROUP İLGİLİ TÜRK STANDARDI/RELATED TURKISH STANDARD TS 5018-1 EN 60988-1A/11 / 12.06.2013 - TS 5018-1 EN 60988-1A/11 / 09.03.2006</p> <p>Belge Sahibi Kuruluşun Adı PEOPLE ELE APPLIANCE GROUP ZHEJIANG IMPORT & EXPORT CORP</p> <p>Üretim Yeri Adı PEOPLE IND. ZONE, CHEZHAN ROAD 555, LUSHU, YUEQING, ZHEJIANG PROVINCE, CHINA YURTDIŞIÇIN</p> <p>İptal Edilen Belge Numarası (Varırsa) 14.41.01.00.00/TSE-65994</p> <p>Belge Kapsamı Model: RDB67-43</p>
---	--



INNOVATIVE TECHNOLOGY LEADING THE ELECTRICITY

Teknolojide Üretimde İletimde Dağıtımda Kontrolde